

LOCKERS

Freestanding



USA price list

Effective July 13th, 2017

UPDATED - January 15th, 2019
update summary - p.31

artopex[®]



interactive links

page tabs & page references

→ document optimized for dual page viewing

VISUAL INDEX 4

GENERAL INFORMATION

description 7
materials 8
lamine finishes 8
woodgrain direction 8
assembly and hardware 8
noki electronic locks 9
lockers, doors, dividers, tackboard 10
locker accessories 11
finish choices chart 12
specification examples 14
typical layouts 15

LOCKERS

with doors 71" H. 17
with doors and open bottom 71" H. 21
open lockers 71" H. 23
corner module 71" H. 24

LOCKER ISLAND 25

TOPS 26

LOCKERS FOR SHARED BENCHING TABLES

with doors 29" H. 27
with doors 44" H. 27
with doors and open on bottom 44" H. 28
open lockers 44" H. 29
tackboards 44" H. 29

COMPLEMENTS 30

LOCKERS

WITH DOORS - 1 LEVEL - 71" H. 17

S11DL141271
S11DL181271
S12DL142471
S12DL182471
S13DL143671
S13DL183671

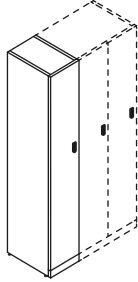

S11DR141271
S11DR181271
S12DR142471
S12DR182471
S13DR143671
S13DR183671

WITH DOORS - 4 LEVELS - 71" H. 20

S41DL141271
S41DL181271
S42DL142471
S42DL182471
S43DL143671
S43DL183671

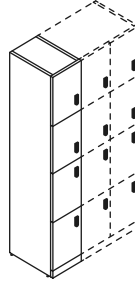

S41DR141271
S41DR181271
S42DR142471
S42DR182471
S43DR143671
S43DR183671

OPEN - 4 LEVELS - 71" H. 23

S41O141271
S41O181271
S42O142471
S42O182471
S43O143671
S43O183671

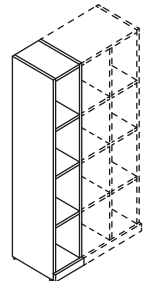

WITH DOORS - 2 LEVELS - 71" H. 18

S21DL141271
S21DL181271
S22DL142471
S22DL182471
S23DL143671
S23DL183671

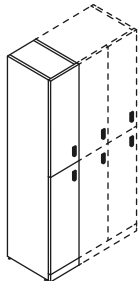

S21DR141271
S21DR181271
S22DR142471
S22DR182471
S23DR143671
S23DR183671

WITH DOORS - AND OPEN ON BOTTOM - 3 LEVELS - 71" H. 21

S31DOL141271
S31DOL181271
S32DOL142471
S32DOL182471
S33DOL143671
S33DOL183671

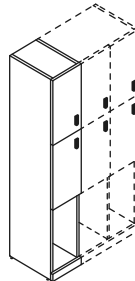

S31DOR141271
S31DOR181271
S32DOR142471
S32DOR182471
S33DOR143671
S33DOR183671

CORNER MODULE - 71" H. 24

MC1471

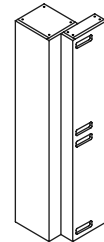

WITH DOORS - 3 LEVELS - 71" H. 19

S31DL141271
S31DL181271
S32DL142471
S32DL182471
S33DL143671
S33DL183671

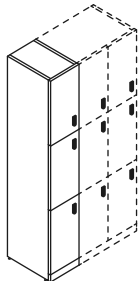

S31DR141271
S31DR181271
S32DR142471
S32DR182471
S33DR143671
S33DR183671

WITH DOORS - AND OPEN ON BOTTOM - 4 LEVELS - 71" H. 22

S41DOL141271
S41DOL181271
S42DOL142471
S42DOL182471
S43DOL143671
S43DOL183671

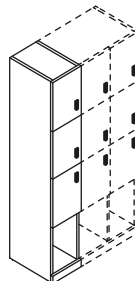

S41DOR141271
S41DOR181271
S42DOR142471
S42DOR182471
S43DOR143671
S43DOR183671

ISLAND LOCKER

WITH DOORS - AND NO TOP - 1 LEVEL - 40" H. 25

S13DL183640

S13DR183640

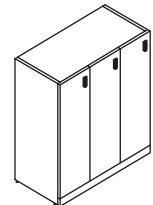

lockers FREESTANDING

visual index

TOPS FOR LOCKERS 26

- LTOP1412
- LTOP1424
- LTOP1436
- LTOP1448
- LTOP1460
- LTOP1472
- LTOP1484
- LTOP1496
- LTOP14108
- LTOP1812
- LTOP1824
- LTOP1836
- LTOP1848
- LTOP1860
- LTOP1872
- LTOP1884
- LTOP1896
- LTOP18108

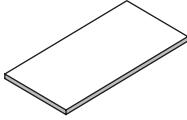

MCD14

- LTOP1836
- LTOP1872
- LTOP18108
- LTOP3636
- LTOP3672
- LTOP36108

LOCKERS FOR SHARED BENCHING TABLES

WITH DOORS - 1 LEVEL - 29" H. 27

- S14DL144829
- S14DL146029

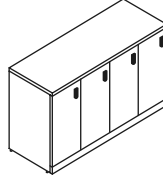

- S14DR144829
- S14DR146029

WITH DOORS - 1 LEVEL - 44" H. 27

- S14DL144844
- S14DL146044

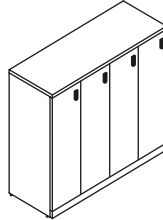

- S14DR144844
- S14DR146044

WITH DOORS - 2 LEVELS - 44" H. 28

- S24DL144844
- S24DL146044

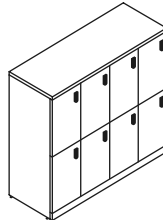

- S24DR144844
- S24DR146044

WITH DOORS - AND OPEN ON BOTTOM - 2 LEVELS - 44" H. 28

- S24DOL144844
- S24DOL146044

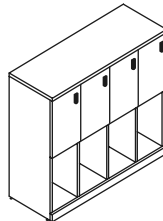

- S24DOR144844
- S24DOR146044

OPEN - 2 LEVELS - 44" H. 29

- S24O144844
- S24O146044

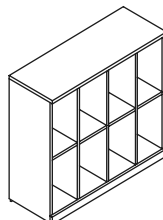

TACKBOARDS 29

- BT4613
- BT5813

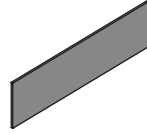

COMPLEMENTS

HOOK 30

AC-HKC



ANTI-TIP FASTENER 30

AC-AAB



BOOT TRAY 30

AC-BB1210

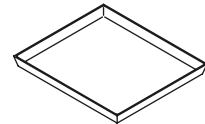

General information

DESCRIPTIONS

The Lockers series offers a variety of personal, secure storage solutions that can be used in a variety of contexts.

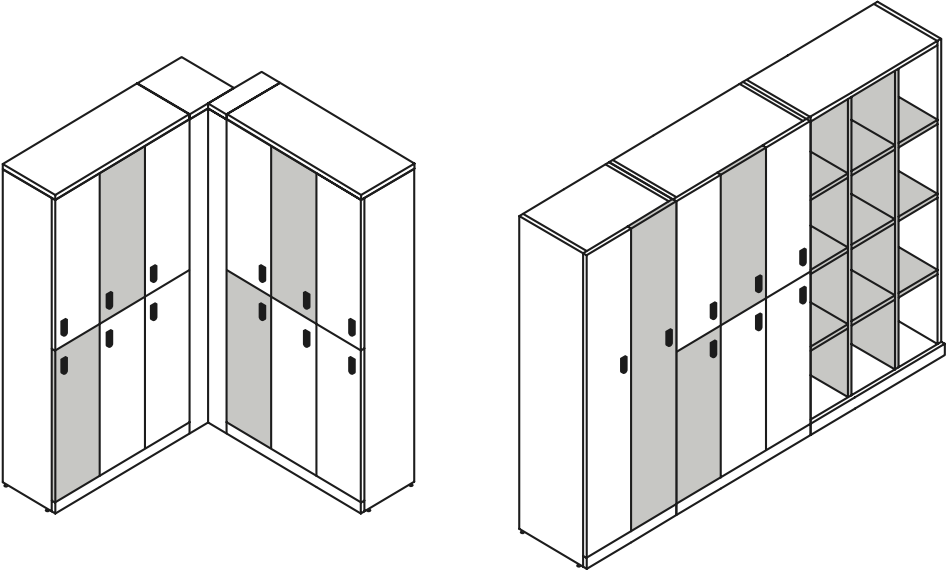

71" high lockers can be grouped along walls to create locker spaces.

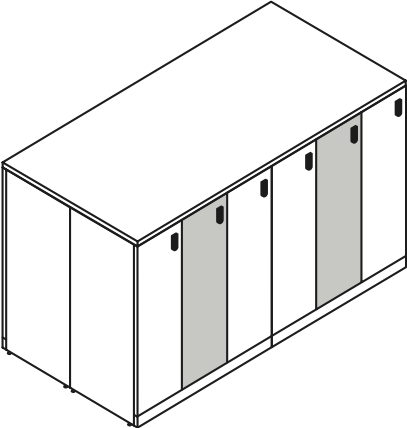

40" high lockers and tops (sold separately) are used to create locker islands.

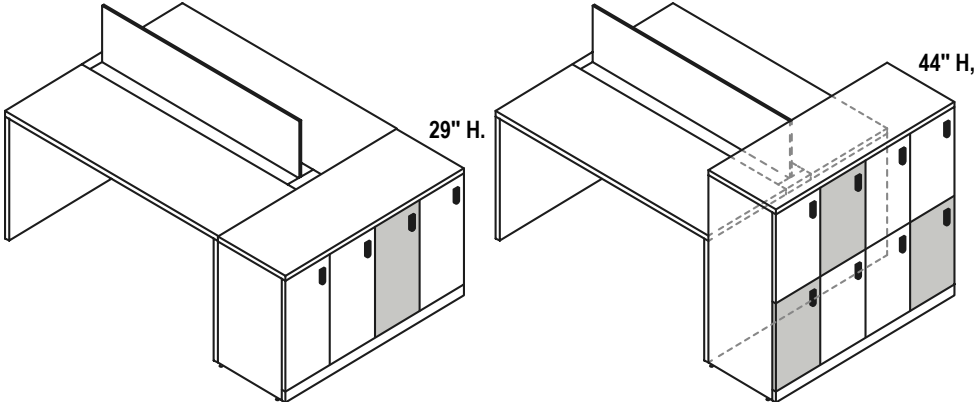

Lockers 29" and 44" high fit perfectly with shared benching tables from the Take Off collection.

MATERIALS

Lockers

The box (top, side, back and kick plate) and the locker doors are made of $\frac{1}{8}$ " (17.5 mm) thick pressed wood. The edges of these panels is $\frac{3}{32}$ " (2.5 mm) thick PVC in a color that matches the laminate. The lockers have full length kick plates aligned with the doors.

Corner module

The front of the corner modules is made of $\frac{1}{8}$ " (17.5 mm) thick pressed wood and edged in $\frac{3}{32}$ " (2.5 mm) thick PVC with a color that matches the laminate.

Tops

The top of the lockers for the shared benching tables and the tops sold separately are made of 1" (25 mm) thick pressed wood. Tops can be ordered in either Thermally Fused or High Pressure Laminate. Add $\frac{1}{16}$ " (1.6 mm) to the thickness for High Pressure Laminate surfaces.

The tops of lockers are edged in $\frac{3}{32}$ " (2.5 mm) thick edge banding in a color that matches the laminate.

LAMINATE FINISHES

The available finishes are divided into 6 categories:

- The "Surface" finish (applied to the 1" surface).
- The "Edge Banding" (1" surface contour).
- The "Base" finish (applied on the sides and back of lockers, and the corner modules).
- The "Door" finish (Door 1 and Door 2)
- The "Divider" finish

Refer to the product description and to the choices of finish, for more details see p.12 and 13.

WOODGRAIN DIRECTION

Tops

The woodgrain runs parallel to the longest side of the surface.

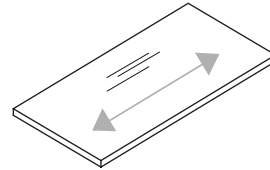

Sides, back, doors and fronts

The woodgrain is positioned vertically on the sides, the back, the front of the corner module and the doors.

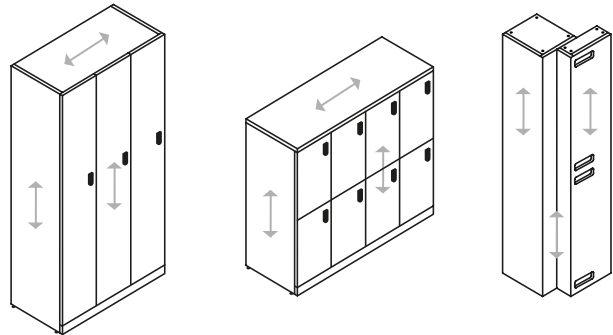

Kick plate

The woodgrain is positioned horizontally on the kick plate.

ASSEMBLY AND HARDWARE

Lockers require no assembly upon delivery except for levelers.

Levelers are adjustable from the inside, by removing the bottom of the locker.



Pre-drilled holes are located on the inside of all lockers to allow them to be screwed together when placed side by side.

NOKI ELECTRONIC LOCKS

All the lockers with doors are equipped with the Noki electronic lock.

The Noki lock is a simple and efficient locking system.

- The combination automatically resets after each use.
- A forgotten code, an absent user... use the master key. An authorized person may also obtain a master code from Artopex.
- After four attempts to open with a wrong code, a brief alarm sounds.
- Powered by a battery (CR2032 included) and easy access to change the battery.

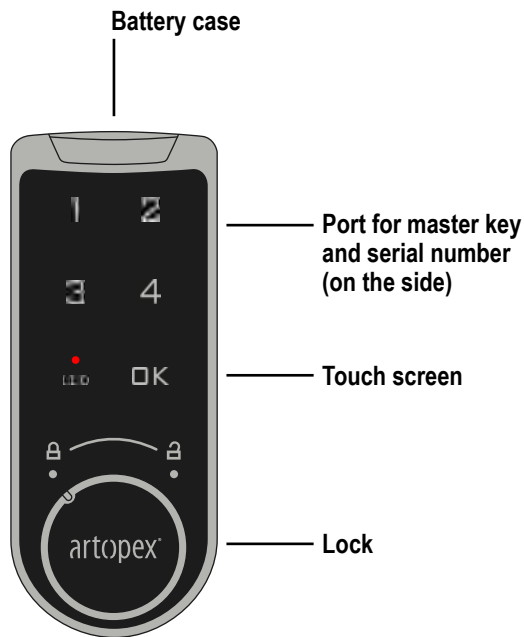

USER

PROGRAM YOUR PERSONAL CODE

- 01** Enter a 6 digit code and turn the lock button to lock. Memorise this code, it will be valid for one use only.
- 02** Re-enter the same 6 digit code again and turn the lock button to unlocked.
- 03** **FORGOTTEN CODE**
Contact Artopex technical support and obtain a master code, unique to your Noki lock.

MANAGER

MASTER KEY OPTION - INDEPENDENT MANAGEMENT

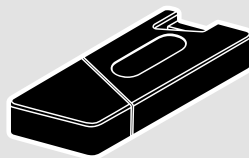

MASTER KEY

- 01** **MANAGEMENT**
Obtain one or more identical master key for use by authorized personnel.
- 02** **FORGOTTEN CODE**
Unlock and reset the lock to its original code 1-2-3-1-2-3 by inserting the master key.

LOCKERS

Assembled lockers are available in a variety of configurations and with the following characteristics :

- Depths: 14" or 18"
- Widths: 12", 24", 36", 48" or 60"
- Heights: 29", 40", 44", or 71"
- 1, 2, 3 or 4 levels of lockers
- 1" tops in Thermally Fused or High Pressure Laminate
- With doors, open or open on bottom
- Doors opening on the left or the right

DOORS

Doors have hinges that allow an opening of 110°.

Lockers are available with a choice of 2 door colors. The choice for Door 1 finish is the main choice (white doors) and the choice for Door 2 finish is the accent choice (grey doors). To have the same finish for Door 1 and Door 2 in the code, enter the same finish for Door 1 and Door 2 in the code.

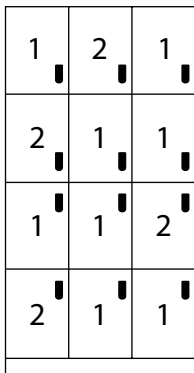

Specification example:
Doors 1 White (BW) and Doors 2 White (BW)

Code Base Doors 1 Doors 2
LK - (S43DL143671) - M (BW) - (BW) - (BW)

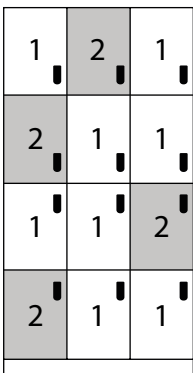

Specification example:
Doors 1 White (BW) and Doors 2 Frost (A)

Code Base Doors 1 Doors 2
LK - (S43DL143671) - M (BW) - (BW) - (A)

DIVIDERS

Inside horizontal and vertical dividers of open lockers can be specified with the same finish as the base or in a different finish.

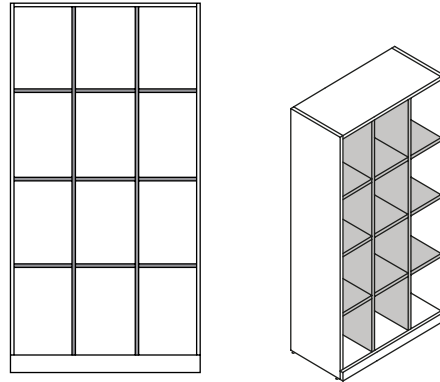

Specification example:
White base (BW) and Frost dividers (A)

Code Base Dividers
LK - (S43O143671) - M (BW) - (A)

TACKBOARD

Tackboards can be installed behind the 44" H. lockers when they are placed against shared benching tables.

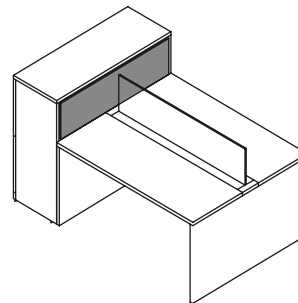

LOCKER ACCESSORIES

Hook

Silver hooks are included in certain lockers with doors and are also sold separately .

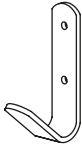

Anti-Tip Fastener

It is strongly advised to add anti-tip fasteners to 71" H. lockers. This fastener is a metal bracket that can be attached to the floor (by removing the bottom of the locker) or onto a wall (by screwing on the top of the locker). Floor or wall attachment hardware is provided by the installer according to the type of floor or wall.

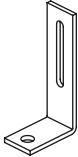

Boot tray

Black plastic trays in HIPS (high impact polystyrene) are available to protect the bottom of the locker shelves.

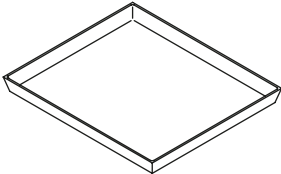

FINISH CHOICES CHART

This is the coding system to use in the specific fields of the list price with reference to choice of colors.
Some exceptions apply, see the charts below or finish charts.

 Colors, especially dark colors, may vary between Thermally Fused Laminate (T.F.L.) and High Pressure Laminate (H.P.L.).

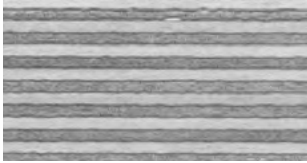
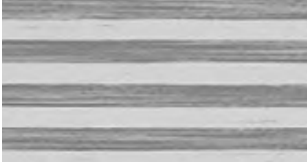
SURFACE		EDGE BANDS (SURFACE)		
T.F.L.	H.P.L.	EDGES REGULAR	EDGES FLUTED	EDGES STRIPED (NARROW)
<p>DOLOMITE FINISH</p> <p>Antique White (MAW) Charcoal (MF) Frost (MA) White (MBW)</p> <p>SUEDE FINISH</p> <p>Cayenne Maple (MCM) Cherry (MCH) Dark Oak (MDK) Honey (MHO)</p> <p>SUPERMAT FINISH</p> <p>Chestnut (MCG) Douglas Pine (MDP) Maritime Maple (MEM) Moka (MPM) Tobacco Cherry (MTC) Willow Grey (MWG)</p> <p>AURA FINISH</p> <p>Carbon (MCB) Dalia (MDA) Galaxy (MGX) Ginger Root (MGG) Sea Salt (MSM) Sesame (MSE) Twilight (MTL)</p>	<p>MAT FINISH</p> <p>Antique White (SAW) Cayenne Maple (SCM) Charcoal (SF) Cherry (SCH) Chestnut (SCG) Dark Oak (SDK) Douglas Pine (SDP) Frost (SA) Honey (SHO) Maritime Maple (SEM) Moka (SPM) Tobacco Cherry (STC) White (SBW) Willow Grey (SWG)</p> <p>NATURAL FINISH</p> <p>Carbon (SCB) Dalia (SDA) Galaxy (SGX) Ginger Root (SGG) Sea Salt (SSM) Sesame (SSE) Twilight (STL)</p> <p>Willow Grey : Matt finish and not supermat finish, like T.F.L.</p>	<p>Aluminum (0W) Antique White (0AW) Black (0N) Carbon (0CB) Cayenne Maple (0CM) Charcoal (0F) Cherry (0CH) Chestnut (0CG) Dalia (0DA) Dark Oak (0DK) Douglas Pine (0DP) Frost (0A) Galaxy (0GX) Ginger Root (0GG) Honey (0HO) Maritime Maple (0EM) Moka (0PM) Sea Salt (0SM) Sesame (0SE) Tobacco Cherry (0TC) Twilight (0TL) White (0BW) Willow Grey (0WG)</p>	<p>Aluminum (3W) Antique White (3AW) Black (3N) Carbon (3CB) Cayenne Maple (3CM) Charcoal (3F) Cherry (3CH) Chestnut (3CG) Dalia (3DA) Dark Oak (3DK) Douglas Pine (3DP) Frost (3A) Galaxy (3GX) Ginger Root (3GG) Honey (3HO) Maritime Maple (3EM) Moka (3PM) Sea Salt (3SM) Sesame (3SE) Tobacco Cherry (3TC) Twilight (3TL) White (3BW) Willow Grey (3WG)</p> <p>1" Edge: 3 grooves</p>	<p>Multiply Maple (0V1) Coordinate with this surface finishes: Maritime Maple - Mocha Douglas Pine</p>  <p>Image actual size 1" thick surface</p> <p>EDGES STRIPED (WIDE)</p> <p>Maple / Honey stripped (0R1) Coordinate with surface finishes: Maritime Maple - Honey</p>  <p>Image actual size 1" thick surface</p>

FINISH CHOICES CHART (CONT'D)

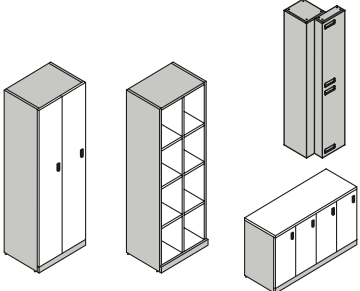
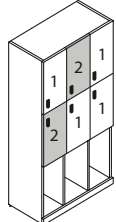
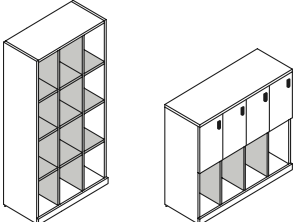
		
BASE	DOORS 1 AND DOORS 2	DIVIDERS
T.F.L.	T.F.L.	T.F.L.
<p>DOLOMITE FINISH</p> <ul style="list-style-type: none"> Antique White (AW) Black (N) Charcoal (F) Frost (A) White (BW) 	<p>DOLOMITE FINISH</p> <ul style="list-style-type: none"> Antique White (AW) Black (N) Charcoal (F) Frost (A) White (BW) 	<p>DOLOMITE FINISH</p> <ul style="list-style-type: none"> Antique White (AW) Black (N) Charcoal (F) Frost (A) White (BW)
<p>SUEDE FINISH</p> <ul style="list-style-type: none"> Cayenne Maple (CM) Cherry (CH) Dark Oak (DK) Honey (HO) 	<p>SUEDE FINISH</p> <ul style="list-style-type: none"> Cayenne Maple (CM) Cherry (CH) Dark Oak (DK) Honey (HO) 	<p>SUEDE FINISH</p> <ul style="list-style-type: none"> Cayenne Maple (CM) Cherry (CH) Dark Oak (DK) Honey (HO)
<p>SUPERMAT FINISH</p> <ul style="list-style-type: none"> Chestnut (CG) Douglas Pine(DP) Maritime Maple (EM) Moka (PM) Tobacco Cherry (TC) Willow Grey (WG) 	<p>SUPERMAT FINISH</p> <ul style="list-style-type: none"> Chestnut (CG) Douglas Pine(DP) Maritime Maple (EM) Moka (PM) Tobacco Cherry (TC) Willow Grey (WG) 	<p>SUPERMAT FINISH</p> <ul style="list-style-type: none"> Chestnut (CG) Douglas Pine(DP) Maritime Maple (EM) Moka (PM) Tobacco Cherry (TC) Willow Grey (WG)
<p>AURA FINISH</p> <ul style="list-style-type: none"> Carbon (CB) Dalia (DA) Galaxy (GX) Ginger Root (GG) Sea Salt (SM) Sesame (SE) Twilight (TL) 	<p>AURA FINISH</p> <ul style="list-style-type: none"> Carbon (CB) Dalia (DA) Galaxy (GX) Ginger Root (GG) Sea Salt (SM) Sesame (SE) Twilight (TL) 	<p>AURA FINISH</p> <ul style="list-style-type: none"> Carbon (CB) Dalia (DA) Galaxy (GX) Ginger Root (GG) Sea Salt (SM) Sesame (SE) Twilight (TL)

SPECIFICATION EXAMPLES

Here are some examples of codes applied to different products.

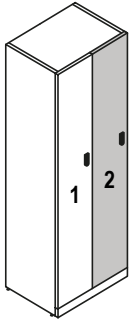

Lockers with doors - 1 level - 71" H.

2 lockers wide: Left
Base: Carbon (CB)
Door 1: Galaxy (GX)
Door 2: Carbon (CB)

SPECIFY

	Code	Base	Door 1	Door 2
LK -	S12DL142471	CB	GX	CB

Order code: **LK-S12DL142471-MCB-GX-CB**

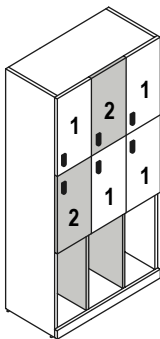

Lockers with doors and open on bottom - 3 levels - 71" H.

3 lockers wide: Right
Base: Galaxy (GX)
Doors 1: Galaxy (GX)
Doors 2: Sea Salt (SM)
Dividers: Sea Salt (SM)

SPECIFY

	Code	Base	Doors 1	Doors 2	Dividers
LK -	S33DOR143671	GX	GX	SM	SM

Order code: **LK-S33DOR143671-MGX-GX-SM-SM**

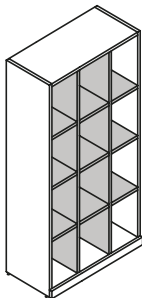

Open lockers - 4 levels - 71" H.

3 lockers wide
Base: Chestnut (CG)
Dividers: Moka (PM)

SPECIFY

	Code	Base	Dividers
LK -	S43O183671	CG	PM

Order code: **LK-S43O183671-MCG-PM**

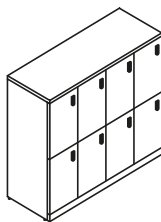

Lockers with doors for shared benching tables - 2 levels - 44" H.

4 lockers wide: Left
Surface: White T.F.L. (MBW)
Edge: Regular White (0BW)
Base: White (BW)
Doors 1: Dark Oak (DK)
Doors 2: Dark Oak (DK)

SPECIFY

	Code	Surface	Edge	Base	Doors 1	Doors 2
LK -	S24DL144844	MBW	0BW	BW	DK	DK

Order code: **LK-S24DL144844-MBW-0BW-BW-DK-DK**

TYPICAL LAYOUTS

Here are some examples of typical layouts.

PRICES SHOWN FOR THE TYPICAL LAYOUTS ARE BASED ON THE FOLLOWING:

- SURFACE 1" THICK IN THERMALLY FUSED LAMINATE (T.F.L.)

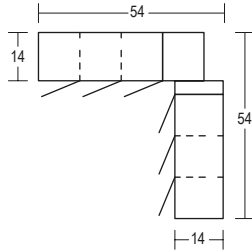
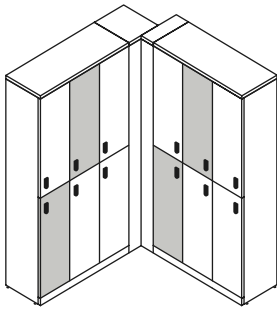

LOCKERS - 001

Lockers with doors, 2 levels, 71" H.

LK-S23DR143671 \$2 363

Corner module 71" H.

LK-MC1471 \$881

Lockers with doors, 2 levels, 71" H.

LK-S23DL143671 \$2 363

Top for locker in a row (2X)

LK-LTOP1436 \$238

Top for corner module

LK-MCD14 \$105

\$5 950

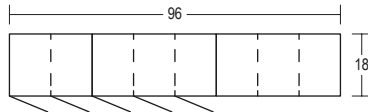
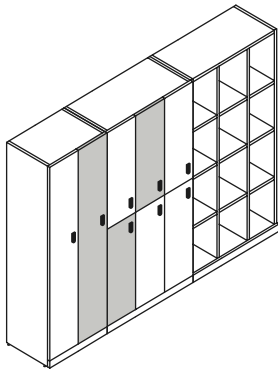

LOCKERS - 002

Lockers with doors, 1 level, 71" H.

LK-S12DL182471 \$1 472

Lockers with doors, 2 levels, 71" H.

LK-S23DL183671 \$2 499

Open lockers, 4 levels, 71" H.

LK-S43O183671 \$1 521

\$5 492

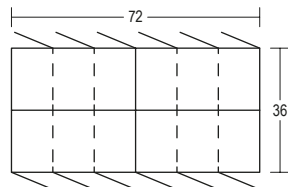
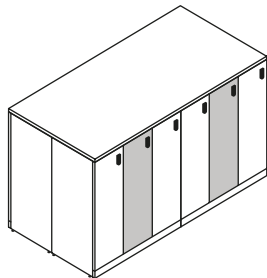

LOCKERS - 003

Lockers with doors and no top,
1 level, 40" H. (4X)

LK-S13DL183640 \$6 080

Top for locker island

LK-LTOP3672 \$277

\$6 357

Price list

lockers

price list

with doors - 1 level - 71" H.

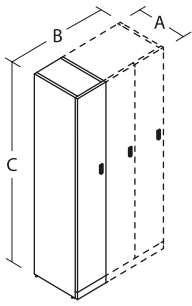

Lockers with doors, 1 level with fixed shelf in the top of the locker.

2 hooks included per locker.

Noki lock included.

Inside dimensions are 12" x 10½" x 55½" for 14" deep and 16" x 10½" x 55½" for 18" deep.

Space above the shelf is 9½".



	Dimensions			Code	Price T.F.L.	Specifications	
	A	B	C			Cu.Ft.	lb(s)
12"							
LEFT	14	12	71	S11DL141271	895	7.3	70.1
	18	12	71	S11DL181271	943	9.2	82.3



24"	14	24	71	S12DL142471	1396	14.6	123.3
LEFT	18	24	71	S12DL182471	1472	18.4	142.9

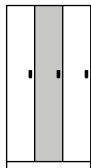

36"	14	36	71	S13DL143671	1885	21.9	176.5
LEFT	18	36	71	S13DL183671	1990	27.6	203.4



12"	14	12	71	S11DR141271	895	7.3	70.1
RIGHT	18	12	71	S11DR181271	943	9.2	82.3

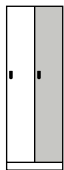

24"	14	24	71	S12DR142471	1396	14.6	123.3
RIGHT	18	24	71	S12DR182471	1472	18.4	142.9

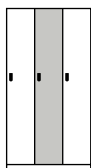

36"	14	36	71	S13DR143671	1885	21.9	176.5
RIGHT	18	36	71	S13DR183671	1990	27.6	203.4

SPECIFY

Code Base Doors 1 Doors 2

LK - - M - -

Specify Code: Consult the above product code list.

Base: Specify the color of the base, see finishes p.13.

Doors 1 (shown above in White) and Doors 2 (if applicable, shown above in Grey): Specify the color for doors 1 and 2, see finishes p.13.

lockers

with doors - 2 levels - 71" H.

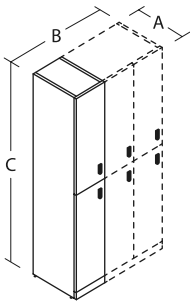

Lockers with doors on 2 levels.
 2 hooks included per locker.
 Noki lock included.
 Inside dimensions are 12" x 10½" x 32½" for 14" deep and 16" x 10½" x 32½" for 18" deep.



	Dimensions			Code	Price T.F.L.	Specifications	
	A	B	C			Cu.Ft.	lb(s)
12"							
LEFT	14	12	71	S21DL141271	1065	7.3	70.4
	18	12	71	S21DL181271	1113	9.2	82.6

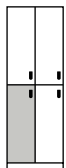

24"							
LEFT	14	24	71	S22DL142471	1735	14.6	123.8
	18	24	71	S22DL182471	1812	18.4	143.3

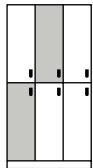

36"							
LEFT	14	36	71	S23DL143671	2363	21.9	177.2
	18	36	71	S23DL183671	2499	27.6	204.1



12"							
RIGHT	14	12	71	S21DR141271	1065	7.3	70.4
	18	12	71	S21DR181271	1113	9.2	82.6

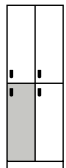

24"							
RIGHT	14	24	71	S22DR142471	1735	14.6	123.8
	18	24	71	S22DR182471	1812	18.4	143.3

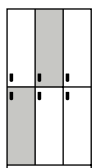

36"							
RIGHT	14	36	71	S23DR143671	2363	21.9	177.2
	18	36	71	S23DR183671	2499	27.6	204.1

SPECIFY

Code Base Doors 1 Doors 2

LK - - M - -

Specify Code: Consult the above product code list.

Base: Specify the color of the base, see finishes p.13.

Doors 1 (shown above in White) and Doors 2 (if applicable, shown above in Grey): Specify the color for doors 1 and 2, see finishes p.13.

lockers

price list

with doors - 3 levels - 71" H.

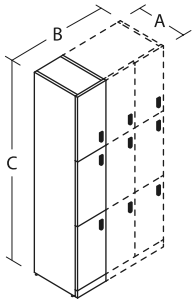

Lockers with doors on 3 levels.

1 hook included per locker.

Noki lock included.

Inside dimensions are 12" x 10½" x 21" for 14" deep and 16" x 10½" x 21" for 18" deep.



	Dimensions			Code	Price T.F.L.	Specifications	
	A	B	C			Cu.Ft.	lb(s)
12"							
LEFT	14	12	71	S31DL141271	1238	7.3	73.4
	18	12	71	S31DL181271	1287	9.2	86.0

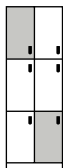

24"							
LEFT	14	24	71	S32DL142471	2081	14.6	129.3
	18	24	71	S32DL182471	2162	18.4	150.4

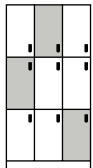

36"							
LEFT	14	36	71	S33DL143671	2913	21.9	185.5
	18	36	71	S33DL183671	3025	27.6	214.8



12"							
RIGHT	14	12	71	S31DR141271	1238	7.3	73.4
	18	12	71	S31DR181271	1287	9.2	86.0

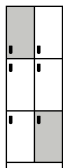

24"							
RIGHT	14	24	71	S32DR142471	2081	14.6	129.3
	18	24	71	S32DR182471	2162	18.4	150.4

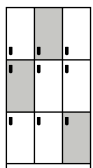

36"							
RIGHT	14	36	71	S33DR143671	2913	21.9	185.5
	18	36	71	S33DR183671	3025	27.6	214.8

SPECIFY

LK - - M - -

Specify Code: Consult the above product code list.

Base: Specify the color of the base, see finishes p.13.

Doors 1 (shown above in White) and Doors 2 (if applicable, shown above in Grey): Specify the color for doors 1 and 2, see finishes p.13.

lockers

with doors - 4 levels - 71" H.

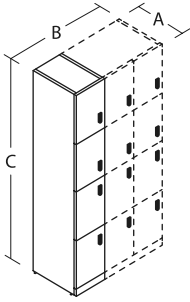

Lockers with doors on 4 levels.

No hooks included.

Noki lock included.

Inside dimensions are 12" x 10½" x 15½" for 14" deep and 16" x 10½" x 15½" for 18" deep.



	Dimensions			Code	Price	Specifications	
	A	B	C		T.F.L.	Cu.Ft.	lb(s)
12"							
LEFT	14	12	71	S41DL141271	1410	7.3	75.7
	18	12	71	S41DL181271	1462	9.2	89.4

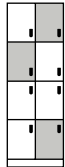

24"							
LEFT	14	24	71	S42DL142471	2426	14.6	134.7
	18	24	71	S42DL182471	2512	18.4	157.3

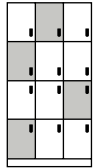

36"							
LEFT	14	36	71	S43DL143671	3431	21.9	193.7
	18	36	71	S43DL183671	3552	27.6	225.4

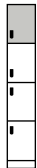

12"							
RIGHT	14	12	71	S41DR141271	1410	7.3	75.7
	18	12	71	S41DR181271	1462	9.2	89.4

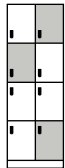

24"							
RIGHT	14	24	71	S42DR142471	2426	14.6	134.7
	18	24	71	S42DR182471	2512	18.4	157.3

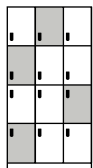

36"							
RIGHT	14	36	71	S43DR143671	3431	21.9	193.7
	18	36	71	S43DR183671	3552	27.6	225.4

SPECIFY

LK - - M - -

Specify Code: Consult the above product code list.

Base: Specify the color of the base, see finishes p.13.

Doors 1 (shown above in White) and Doors 2 (if applicable, shown above in Grey): Specify the color for doors 1 and 2, see finishes p.13.

lockers

price list

with doors - and open on bottom - 3 levels - 71" H.

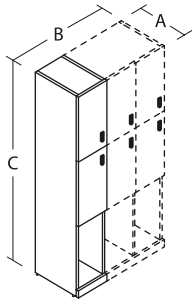

Lockers with doors on 2 levels and open on bottom.

1 hook included per locker with door.

Noki lock included.

Inside dimensions are 12" x 10" x 20½" for 14" deep and 16" x 10" x 20½" for 18" deep.



	Dimensions			Code	Price T.F.L.	Specifications	
	A	B	C			Cu.Ft.	lb(s)
12"							
LEFT	14	12	71	S31DOL141271	1057	7.3	67.9
	18	12	71	S31DOL181271	1108	9.2	80.9

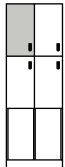

24"							
LEFT	14	24	71	S32DOL142471	1720	14.6	119.1
	18	24	71	S32DOL182471	1802	18.4	140.2

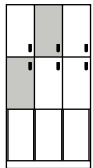

36"							
LEFT	14	36	71	S33DOL143671	2372	21.9	170.2
	18	36	71	S33DOL183671	2485	27.6	199.5



12"							
RIGHT	14	12	71	S31DOR141271	1057	7.3	67.9
	18	12	71	S31DOR181271	1108	9.2	80.9

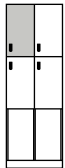

24"							
RIGHT	14	24	71	S32DOR142471	1720	14.6	119.1
	18	24	71	S32DOR182471	1802	18.4	140.2

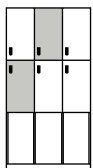

36"							
RIGHT	14	36	71	S33DOR143671	2372	21.9	170.2
	18	36	71	S33DOR183671	2485	27.6	199.5

SPECIFY

Code Base Doors 1 Doors 2 Dividers

LK - - M - - -

Specify Code: Consult the above product code list.

Base: Specify the color of the base, see finishes p.13.

Doors 1 (shown above in White) and Doors 2 (if applicable, shown above in Grey): Specify the color for doors 1 and 2, see finishes p.13.

Dividers (laminate): Specify color for the dividers, see finishes, p.13.

with doors - and open on bottom - 4 levels - 71" H.

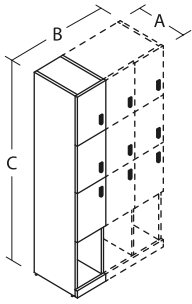

Lockers with doors on 3 levels and open on bottom.

No hook included.

Noki lock included.

Inside dimensions are 12" x 10½" x 15" for 14" deep and 16" x 10½" x 15" for 18" deep.



	Dimensions			Code	Price	Specifications	
	A	B	C		T.F.L.	Cu.Ft.	lb(s)
12"							
LEFT	14	12	71	S41DOL141271	1241	7.3	71.8
	18	12	71	S41DOL181271	1294	9.2	85.5

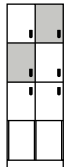

24"							
LEFT	14	24	71	S42DOL142471	2088	14.6	126.0
	18	24	71	S42DOL182471	2175	18.4	149.7

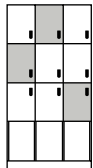

36"							
LEFT	14	36	71	S43DOL143671	2923	21.9	182.2
	18	36	71	S43DOL183671	3044	27.6	213.6

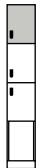

12"							
RIGHT	14	12	71	S41DOR141271	1241	7.3	71.8
	18	12	71	S41DOR181271	1294	9.2	85.5

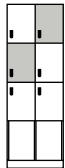

24"							
RIGHT	14	24	71	S42DOR142471	2088	14.6	126.0
	18	24	71	S42DOR182471	2175	18.4	149.7

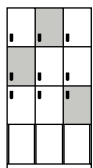

36"							
RIGHT	14	36	71	S43DOR143671	2923	21.9	182.2
	18	36	71	S43DOR183671	3044	27.6	213.6

SPECIFY

Code Base Doors 1 Doors 2 Dividers

LK - - M - - -

Specify Code: Consult the above product code list.

Base: Specify the color of the base, see finishes p.13.

Doors 1 (shown above in White) and Doors 2 (if applicable, shown above in Grey): Specify the color for doors 1 and 2, see finishes p.13.

Dividers (laminated): Specify color for the dividers, see finishes, p.13.

lockers

open - 4 levels - 71" H.

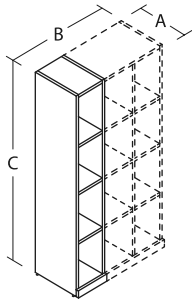

Open lockers on 4 levels.

No hook included.

Inside dimensions are 12" x 10½" x 15½" for 14" deep and 16" x 10½" x 15½" for 18" deep.



12"

Dimensions			Code	Price	Specifications	
A	B	C		T.F.L.	Cu.Ft.	lb(s)
14	12	71	S41O141271	733	7.3	60.1
18	12	71	S41O181271	785	9.2	73.8

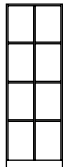

24"

14	24	71	S42O142471	1073	14.6	103.5
18	24	71	S42O182471	1159	18.4	126.1

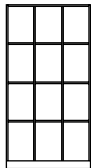

36"

14	36	71	S43O143671	1400	21.9	146.9
18	36	71	S43O183671	1521	27.6	178.5

SPECIFY

Code Base Dividers

LK - - M -

Specify Code: Consult the above product code list.

Base: Specify the color of the base, see finishes p.13.

Dividers (laminates): Specify color for the dividers, see finishes, p.13.

corner module - 71" H.

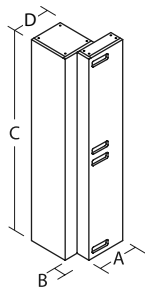

Corner finishing module for lockers 71" H.
 Reversible, one 4" fixed side and one side width-adjustable up to 9½".
 The 14" deep corner module can be used with lockers 14" or 18" deep.

Dimensions				Code	Price	Specifications	
A	B	C	D		T.F.L.	Cu.Ft.	lb(s)
14	4	71	12½	MC1471	881	8.8	61.0

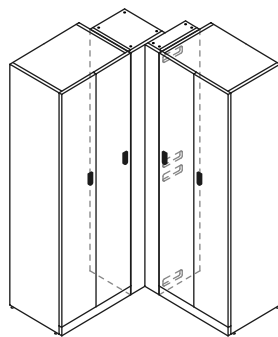

SPECIFY

Code Base
 LK - - M

Specify Code: Consult the above product code list.
Base: Specify the color of the base, see finishes p.13.

with doors - and no top - 1 level - 40" H.

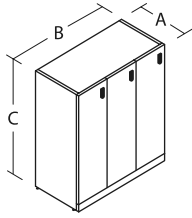

Lockers with doors on 1 level, used to create work islands of 41" H.
 Top sold separately, see next page.
 1 hook included per locker.
 Noki lock included.
 Inside dimensions are 16" x 10½" x 36".



LEFT

Dimensions			Code	Price	Specifications	
A	B	C		T.F.L.	Cu.Ft.	lb(s)
18	36	40	S13DL183640	1520	15.8	119.9

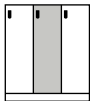

RIGHT

18	36	40	S13DR183640	1520	15.8	119.9
----	----	----	-------------	------	------	-------

SPECIFY

Code Base Doors 1 Doors 2
 LK - - M - -

Specify Code: Consult the above product code list.

Base: Specify the color of the base, see finishes p.13.

Doors 1 (shown above in White) and Doors 2 (if applicable, shown above in Grey): Specify the color for doors 1 and 2, see finishes p.13.

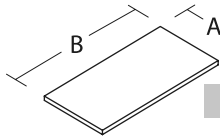

Tops for lockers of 14" or 18" deep.

TOPS FOR 71" LOCKERS IN A ROW

Dimensions		Code	Price 1"		Specifications	
A	B		T.F.L.	H.P.L.	Cu.Ft.	lb(s)
14	12	LTOP1412	91	113	0.1	4.4
14	24	LTOP1424	106	146	0.2	8.7
14	36	LTOP1436	119	180	0.3	13.1
14	48	LTOP1448	141	221	0.4	17.4
14	60	LTOP1460	154	254	0.4	21.7
14	72	LTOP1472	168	288	0.5	26.2
14	84	LTOP1484	184	336	0.6	30.5
14	96	LTOP1496	260	403	0.8	34.9
14	108	LTOP14108	272	433	0.9	39.2
18	12	LTOP1812	96	123	0.1	5.6
18	24	LTOP1824	112	164	0.2	11.2
18	36	LTOP1836	121	171	0.4	16.8
18	48	LTOP1848	154	255	0.5	22.4
18	60	LTOP1860	173	274	0.6	28.0
18	72	LTOP1872	196	321	0.7	33.6
18	84	LTOP1884	233	394	0.9	39.2
18	96	LTOP1896	283	468	1.0	44.8
18	108	LTOP18108	287	481	1.1	50.4

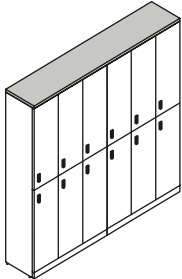

Tops for corner module 14" deep can be used with both 14" or 18" deep lockers.

TOPS FOR CORNER MODULE 71"

14	MCD14	105	133	0.3	6.4
----	-------	-----	-----	-----	-----

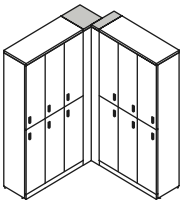

TOPS FOR LOCKER ISLAND 41"

18	36	LTOP1836	121	171	0.4	16.8
18	72	LTOP1872	196	321	0.7	33.6
18	108	LTOP18108	287	481	1.1	50.4
36	36	LTOP3636	174	322	0.8	33.6
36	72	LTOP3672	277	570	1.5	67.3
36	108	LTOP36108	421	836	2.3	100.8

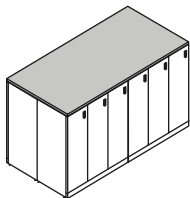

SPECIFY

Code Surface Edge
 LK - - /

Specify Code: Consult the above product code list.

Surface / Edge: Specify surface and edge color, see finishes p.12.

lockers for shared benching tables

price list

with doors - 1 level - 29" H.

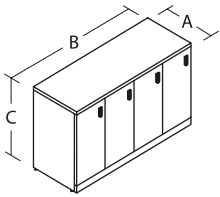

Lockers with doors on 1 level are the same height as the shared benching tables surfaces.

1 hook included per locker.

Noki lock included.

Inside dimensions are 12" x 10½" x 24" for 48" wide lockers
and 12" x 13½" x 24" for 60" wide lockers.

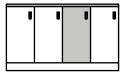
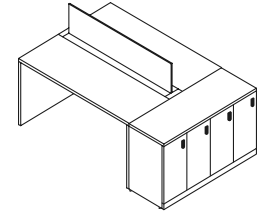

LEFT

48"

Dimensions			Code	Price 1"		Specifications	
A	B	C		T.F.L.	H.P.L.	Cu.Ft.	lb(s)
14	48	29	S14DL144829	1603	1746	12.1	104.4
14	60	29	S14DL146029	1685	1863	15.1	123.0

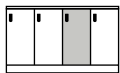

RIGHT

48"

14	48	29	S14DR144829	1603	1746	12.1	104.4
14	60	29	S14DR146029	1685	1863	15.1	123.0

with doors - 1 level - 44" H.

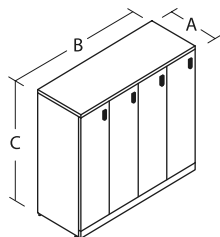

Lockers with doors on 1 level are the same height as the privacy panels on the shared benching table surfaces.

2 hooks included per locker.

Noki lock included.

Inside dimensions are 12" x 10½" x 39" for 48" wide lockers
and 12" x 13½" x 39" for 60" wide lockers.

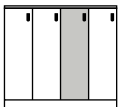
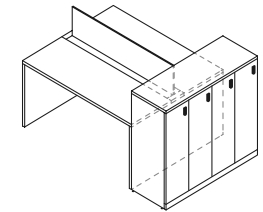

LEFT

48"

60"

Dimensions			Code	Price		Specifications	
A	B	C		T.F.L.	H.P.L.	Cu.Ft.	lb(s)
14	48	44	S14DL144844	1807	1951	18.3	147.0
14	60	44	S14DL146044	1912	2091	22.9	172.1

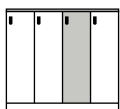

RIGHT

48"

60"

14	48	44	S14DR144844	1807	1951	18.3	147.0
14	60	44	S14DR146044	1912	2091	22.9	172.1

SPECIFY

Code Surface Edge Base Doors 1 Doors 2

LK - - / - - -

Specify Code: Consult the above product code list.

Surface / Edge / Base: Specify surface, edge and base color, see finishes p.12.

Doors 1 (shown above in White) and Doors 2 (if applicable, shown above in Grey): Specify the color for doors 1 and 2, see finishes p.13.

lockers for shared benching tables

price list

with doors - 2 levels - 44" H.

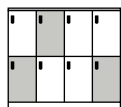
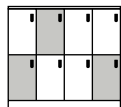
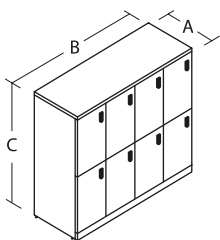

Lockers with doors on 2 levels are the same height as the privacy panel on shared benching tables.
 1 hook included per locker.
 Noki lock included.
 Inside dimensions are 12" x 10½" x 19" for 48" wide lockers
 and 12" x 13½" x 19" for 60" wide lockers.

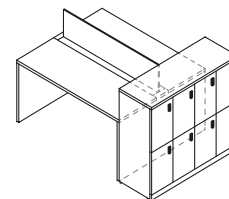

	Dimensions			Code	Price		Specifications	
	A	B	C		T.F.L.	H.P.L.	Cu.Ft.	lb(s)
LEFT								
48"	14	48	44	S24DL144844	2563	2706	18.3	158.1
60"	14	60	44	S24DL146044	2682	2861	22.9	185.9

	Dimensions			Code	Price		Specifications	
	A	B	C		T.F.L.	H.P.L.	Cu.Ft.	lb(s)
RIGHT								
48"	14	48	44	S24DR144844	2563	2706	18.3	158.1
60"	14	60	44	S24DR146044	2682	2861	22.9	185.9

SPECIFY

Code Surface Edge Base Doors 1 Doors 2

LK - - / - - -

Specify Code: Consult the above product code list.
Surface / Edge / Base: Specify surface, edge and base color, see finishes p.12.
Doors 1 (shown above in White) and Doors 2 (if applicable, shown above in Grey): Specify the color for doors 1 and 2, see finishes p.13.

with doors - and open on bottom - 2 levels - 44" H.

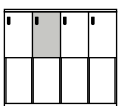
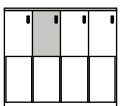
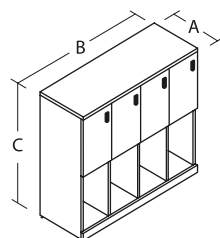

Lockers with doors on 1 level and open on bottom, are the same height as the privacy panel on the shared benching tables.
 1 hook included per locker with door.
 Noki lock included.
 Inside dimensions are 12" x 10½" x 18½" for 48" wide lockers
 and 12" x 13½" x 18½" for 60" wide lockers.

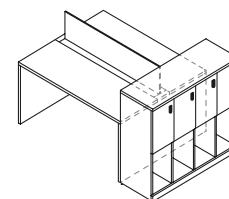

	Dimensions			Code	Price		Specifications	
	A	B	C		T.F.L.	H.P.L.	Cu.Ft.	lb(s)
LEFT								
48"	14	48	44	S24DOL144844	1852	1995	18.3	140.0
60"	14	60	44	S24DOL146044	1955	2133	22.9	163.6

	Dimensions			Code	Price		Specifications	
	A	B	C		T.F.L.	H.P.L.	Cu.Ft.	lb(s)
RIGHT								
48"	14	48	44	S24DOR144844	1852	1995	18.3	140.0
60"	14	60	44	S24DOR146044	1955	2133	22.9	163.6

SPECIFY

Code Surface Edge Base Doors 1 Doors 2 Dividers

LK - - / - - - -

Specify Code: Consult the above product code list.
Surface / Edge / Base: Specify surface, edge and base color, see finishes p.12.
Doors 1 (shown above in White) and Doors 2 (if applicable, shown above in Grey): Specify the color for doors 1 and 2, see finishes p.13.
Dividers (laminated): Specify color for the dividers, see finishes, p.13.

lockers for shared benching tables

price list

open - 2 levels - 44" H.

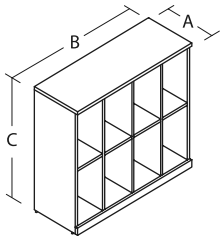

Open lockers on 2 levels are the same height as the privacy panel on the shared benching table.
No hook included.
Inside dimensions are 12" x 10½" x 19" for 48" wide lockers
and 12" x 13½" x 19" for 60" wide lockers.

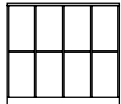
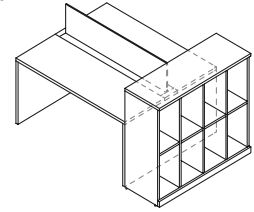

48"

60"

Dimensions			Code	Price			Specifications	
A	B	C		T.F.L.	H.P.L.	Cu.Ft.	lb(s)	
14	48	44	S24O144844	1142	1286	18.3	121.8	
14	60	44	S24O146044	1227	1406	22.9	141.3	

SPECIFY

Code Surface Edge Base Dividers
LK - - / - -

Specify Code: Consult the above product code list.

Surface / Edge / Base: Specify surface, edge and base color, see finishes p.12.

Dividers (laminated): Specify color for the dividers, see finishes, p.13.

tackboard 44" H.

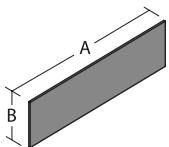

Tackboard for 44" H. lockers beside shared benching tables.
Attach with velcro strips.

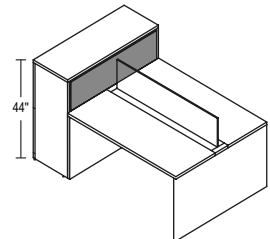

Dimensions		Code	Price					Specifications	
A	B		Com / Gr.1	Gr.2	Gr.3	Gr.4	Gr.5	Cu.Ft.	lb(s)
48	13	BT4613	198	224	243	253	262	1.2	12
60	13	BT5813	212	244	268	276	282	1.5	16

SPECIFY

Code Fabric
AC - -

Specify Code: Consult the above product code list.

Fabric: Refer to current Artopex panel fabric card.

hook



Metal hook to attach inside the lockers.
Sold individually, silver finish.

	Code	Price	Specifications	
			Cu.Ft.	lb(s)
1 hook	AC-HKC	17	0.1	1.0

anti-tip fastener



Metal bracket to prevent tilting, attaches to floor or wall.
Sold individually, black finish.
Strongly advised to use with 71" H. lockers.

	Code	Price	Specifications	
			Cu.Ft.	lb(s)
1 fastener	AC-AAB	21	0.1	1.0

boot tray

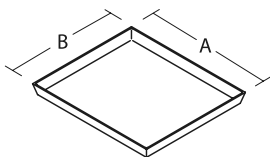

Boot tray to protect bottom of lockers.
Black plastic finish.

Dimensions		Code	Price	Specifications	
A	B			Cu.Ft.	lb(s)
12	10	AC-BB1210	0.2	1.0	

SUMMARY OF UPDATES

May 1st 2018

PAGES	SECTION	PRODUCT	MODIFICATION
p.3 and 30	Table of content	Accessories	Title: Accessories - now called Complements (in all Artopex price lists).
p.12-13	General information	Finish choices chart	Laminate finishes is updated. Refer to the new Artopex laminate cards for new finishes and corrections.
p.17 to 24	Price list	All the titles	Title corrections: Lockers with doors is changed for: Lockers.
p.25	Lockers with doors	With doors - and no top - 1 level - 40"H.	Title correction: Lockers with doors - without top - 1 level - 40" H., is now; Locker Island - with doors - and no top - 1 level - 40" H.
p.27 to 29	Lockers with doors		Title corrections: Lockers with doors is now changed for: Lockers for shared benching tables - with doors.

September 10th 2018

PAGES	SECTION	PRODUCT	MODIFICATION
		Conditions & Guarantees	Conditions & guarantees have been removed from the Lockers price list. Please refer to the Artopex Warranty Guide in effect at artopex.com in the Member Zone / Documentation section.

*Designing, manufacturing, advising, planning
and supporting: that's the art that
distinguishes our purpose at Artopex.*

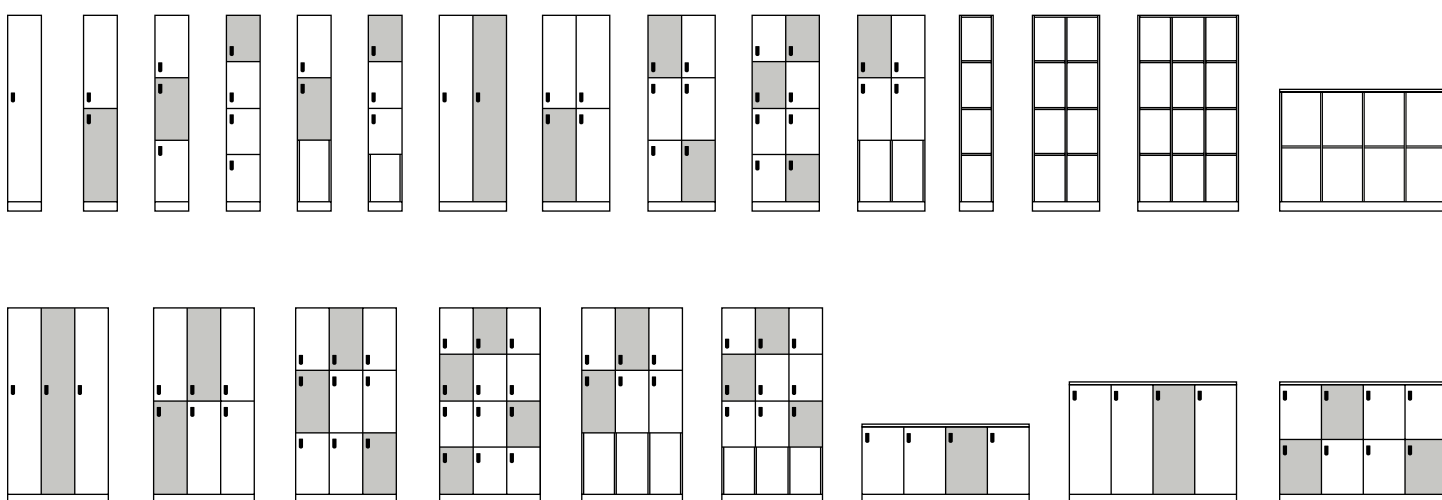

<p>ARTOPEX Head Office artopex.com</p>	<p>800 Vadnais Street Granby, QC, Canada J2J 1A7 T 1 800 378 0189</p>
---------------------------------------------------------------------------------	-------------------------------------------------------------------------------