

Metal

Storage



USA
price list

Effective August 15th, 2016

UPDATED - June 17th 2019
summary updates - p.75

artopex[®]

Interactive Buttons



Main Table of Contents.



Product Index.



The first page of the General Information section.



Go back to the page you previously viewed.



interactive links

index, page tabs & page references

→ document optimized for single page view

<i>Visual index</i>	04
<i>General information</i>	12
series descriptions	13
storage specifications	13
locks	15
pedestals	17
custom storage units	19
specification examples	21
<i>Lateral files</i>	22
2-drawers	23
3-drawers	25
4-drawers	27
5-drawers	29
6-drawers	31
<i>Combined storage</i>	34
with drawers	35
with doors	36
with wardrobes	37
vertical	38
<i>Pedestals</i>	40
pedestals with levellers	41
mobile pedestals	43
Compact mobile pedestals	46
<i>Cabinets</i>	50
various height cabinets	51
overfile cabinets	56
<i>Bookcases</i>	58
various height bookcases	59
<i>Complements</i>	64
lateral files	65
pedestals	66
cabinets and bookcases	69

Visual index



Lateral files

2 drawers - fixed fronts

23

55-21-030-33
57-21-030-33
45-21-036-33
47-21-036-33
55-21-036-33
57-21-036-33
55-21-042-33
57-21-042-33

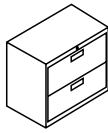

4 drawers - recending doors

28

55-41-030-1113
57-41-030-1113
45-41-036-1113
47-41-036-1113
55-41-036-1113
57-41-036-1113
55-41-042-1113
57-41-042-1113



2 drawers - recending door

24

55-21-030-13
57-21-030-13
45-21-036-13
47-21-036-13
55-21-036-13
57-21-036-13
55-21-042-13
57-21-042-13

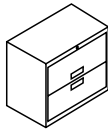

5 drawers - fixed fronts

29

55-51-030-13333
57-51-030-13333
45-51-036-13333
47-51-036-13333
55-51-036-13333
57-51-036-13333
55-51-042-13333
57-51-042-13333

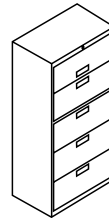

3 drawers - fixed fronts

25

55-31-030-333
57-31-030-333
45-31-036-333
47-31-036-333
55-31-036-333
57-31-036-333
55-31-042-333
57-31-042-333

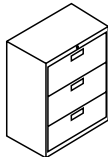

5 drawers - recending doors

30

55-51-030-11113
57-51-030-11113
45-51-036-11113
47-51-036-11113
55-51-036-11113
57-51-036-11113
55-51-042-11113
57-51-042-11113

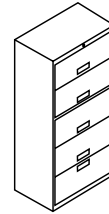

3 drawers - recending doors

26

55-31-030-113
57-31-030-113
45-31-036-113
47-31-036-113
55-31-036-113
57-31-036-113
55-31-042-113
57-31-042-113

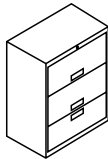

6 drawers - fixed fronts

31

55-61-030-213333
57-61-030-213333
55-61-036-213333
57-61-036-213333



4 drawers - fixed fronts

27

55-41-030-3333
57-41-030-3333
45-41-036-3333
47-41-036-3333
55-41-036-3333
57-41-036-3333
55-41-042-3333
57-41-042-3333

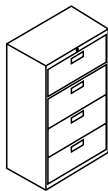

6 drawers - recending doors

32

55-61-030-211113
57-61-030-211113
55-61-036-211113
57-61-036-211113



Combined storage

With drawers

35

45-21-036-FUU3
47-21-036-FUU3

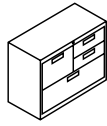

45-21-036-UUF3
47-21-036-UUF3

55-54-024-24-SRDV
57-54-024-24-SRDV

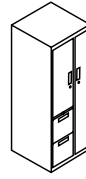

With doors

36

45-49-036-Y33
47-49-036-Y33
55-49-036-Y33
57-49-036-Y33

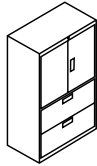

55-54-024-24-SLDV
57-54-024-24-SLDV

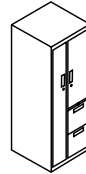

Vertical

38

45-59-036-YY33
47-59-036-YY33
55-59-036-YY33
57-59-036-YY33

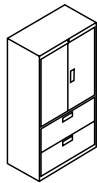

55-54-015-24-SRC
57-54-015-24-SRC

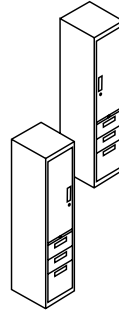

45-59-036-Y333
47-59-036-Y333
55-59-036-Y333
57-59-036-Y333

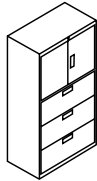

55-54-015-24-SLC
57-54-015-24-SLC

55-54-015-24-SRD
57-54-015-24-SRD

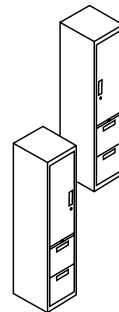

With wardrobes

37

55-54-024-24-SRCV
57-54-024-24-SRCV

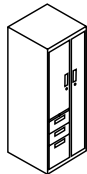

55-54-015-24-SLD
57-54-015-24-SLD

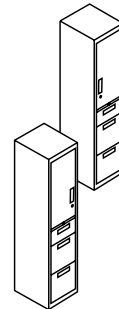

55-54-024-24-SLCV
57-54-024-24-SLCV

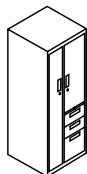

55-54-015-24-SRB
57-54-015-24-SRB

55-54-015-24-SLB
57-54-015-24-SLB

Pedestals

Pedestals with levers

41

MP45-18-1212
MP47-18-1212
MP45-22-1212
MP47-22-1212
MP45-28-1212
MP47-28-1212

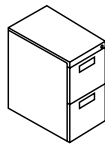

MP45-18-6612
MP47-18-6612
MP45-22-6612
MP47-22-6612
MP45-28-6612
MP47-28-6612

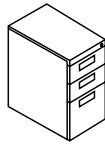

MP45-18-33612
MP45-22-33612
MP45-28-33612

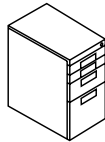

MP45-18-3612
MP45-22-3612
MP45-28-3612

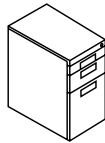

MP45-18-3612CA
MP45-22-3612CA
MP45-28-3612CA



MP45-18-612CA
MP47-18-612CA
MP45-22-612CA



Compact mobile pedestals

46

MP15UUFCA-3067-LT1
MP15UUFCA-3090-LT1
MP15UUFCA-3002-LT1

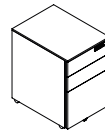

MP15UFCA-3067-LT1
MP15UFCA-3090-LT1
MP15UFCA-3002-LT1

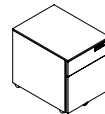

MP12UFCA-3067-LT1
MP12UFCA-3090-LT1
MP12UFCA-3002-LT1

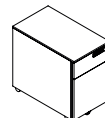

Mobile pedestals

43

MP45-18-1212CA
MP47-18-1212CA
MP45-22-1212CA
MP47-22-1212CA
MP45-28-1212CA
MP47-28-1212CA

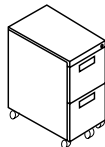

MP45-18-6612CA
MP47-18-6612CA
MP45-22-6612CA
MP47-22-6612CA
MP45-28-6612CA
MP47-28-6612CA



MP45-18-33612CA
MP45-22-33612CA
MP45-28-33612CA

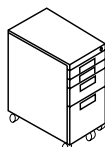

Felt cushion for compact mobile pedestals

47

AC-CUSFMP15
AC-CUSFMP12

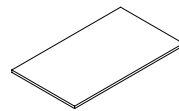

Fabric cushion for compact mobile pedestals

48

AC-CUSMP15
AC-CUSMP12

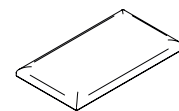

Cabinets

Cabinets - 27 15/16" H.

51

- 55-28-030-Y
- 57-28-030-Y
- 55-28-036-Y
- 57-28-036-Y
- 55-28-042-Y
- 57-28-042-Y

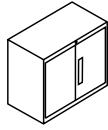

Overfile cabinets - 24 1/4" H.

56

- 55-80-030-B
- 55-80-036-B
- 55-80-042-B

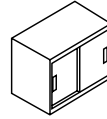

Overfile cabinets - 25 7/16" H.

57

- 55-85-030-B
- 55-85-036-B
- 55-85-042-B

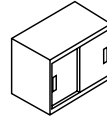

Cabinets - 40 1/16" H.

52

- 55-38-030-YY
- 57-38-030-YY
- 55-38-036-YY
- 57-38-036-YY
- 55-38-042-YY
- 57-38-042-YY

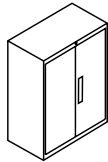

Cabinets - 53 3/8" H.

53

- 55-48-030-YYY
- 57-48-030-YYY
- 55-48-036-YYY
- 57-48-036-YYY
- 55-48-042-YYY
- 57-48-042-YYY

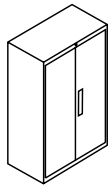

Cabinets - 65 1/2" H.

54

- 55-58-030-YYY
- 57-58-030-YYY
- 55-58-036-YYY
- 57-58-036-YYY
- 55-58-042-YYY
- 57-58-042-YYY

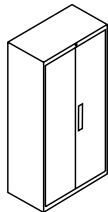

Cabinets - 77 5/8" H.

55

- 55-68-030-YYYY
- 57-68-030-YYYY
- 55-68-036-YYYY
- 57-68-036-YYYY
- 55-68-042-YYYY
- 57-68-042-YYYY

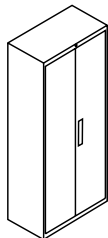

Bookcases

Bookcases - 27 15/16" H. 59

- 70-20-030-Y
- 70-20-036-Y
- 70-20-042-Y

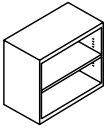

Bookcases - 40 1/16" H. 60

- 70-30-030-YY
- 70-30-036-YY
- 70-30-042-YY

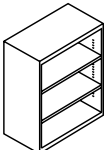

Bookcases - 53 3/8" H. 61

- 70-40-030-YYY
- 70-40-036-YYY
- 70-40-042-YYY

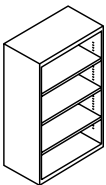

Bookcases - 65 1/2" H. 62

- 70-50-030-YYY
- 70-50-036-YYY
- 70-50-042-YYY

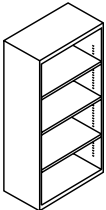

Bookcases - 77 5/8" H. 63

- 70-60-036-YYYY

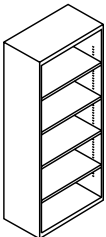

Complements

Lateral file drawer compressor 65

AC-04-030
AC-04-036
AC-04-042

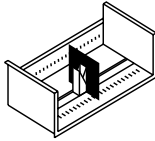

Dividers - sold by the unit 65

AC-04-281
AC-04-282
AC-04-283

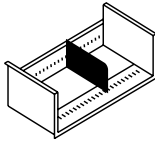

Card tray - sold by the unit 65

AC-04-451
AC-04-452
AC-04-453

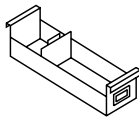

Lateral file counterweight 65

AC-04-828

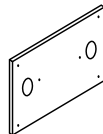

Side-to-side hanging bar - sold by the unit 66

AC-04-830
AC-04-836
AC-04-842

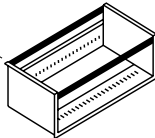

Front-to-back hanging bar - sold by the unit 66

AC-04-884

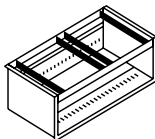

Pencil tray 66

AC-MP0814

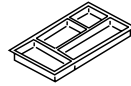

Dividers for 6" drawer 66

AC-MPA0804

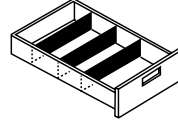

Compressor for 12" drawer 67

AC-MP0818
AC-MP0822
AC-MP0828

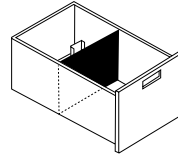

Adjustable stopper 67

AC-MPS

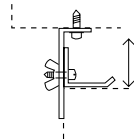

Counterweight for pedestal 67

AC-MPAC23
AC-MPAC26

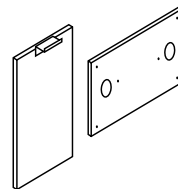

Levellers 68

AC-MP1



Casters 68

AC-MP2

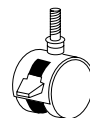

Cushion 68

AC-CUS1518
AC-CUS1522

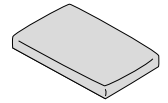

Additional shelves - regular (without perforations) 69

AC45-Y-030
AC45-Y-036
AC45-Y-042

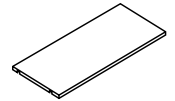

Additional shelves - perforated 70

AC45-P-030
AC45-P-036
AC45-P-042

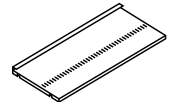

Dividers 71

AC-04-KL06
AC-04-KL45

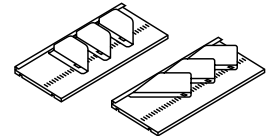

Shelves for overfile cabinets 72

AC-B-030
AC-B-036
AC-B-042

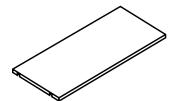

General information



Series description

	Specifications	Pull
45 SERIES	<ul style="list-style-type: none"> Economy series. Durable construction. Available width: 36". 	<ul style="list-style-type: none"> Central pull in aluminum.
47 SERIES	<ul style="list-style-type: none"> Economy series. Durable construction. Available width: 36". 	<ul style="list-style-type: none"> Full length pull integrated into the construction of the door.
55 SERIES	<ul style="list-style-type: none"> Superior quality series. Extra sturdy construction, reinforced base. Available widths: 30", 36" and 42". 	<ul style="list-style-type: none"> Central pull in aluminum.
57 SERIES	<ul style="list-style-type: none"> Superior quality series. Extra sturdy construction, reinforced at base. Available widths: 30", 36" and 42". 	<ul style="list-style-type: none"> Full length pull integrated into the design of the door.
70 SERIES	<ul style="list-style-type: none"> Bookcase 	

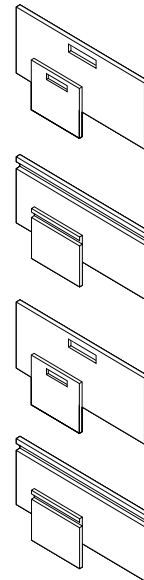

Storage specifications

Drawer capability

The functionality of the metal lateral file drawers varies depending on the number and type of drawers in the file cabinet.

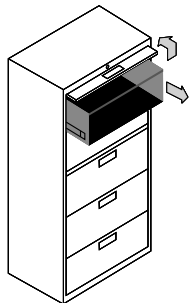

The top drawer on all of the 5-drawer high units is manufactured with a receding door and pul out shelf (even when the file cabinet is specified with fixed fronts).

The top drawer on all of the 6 high units is manufactured with a receding door and fixed shelf, the 5th drawer is the same as the unit above (even when the file cabinet is specified with fixed fronts).

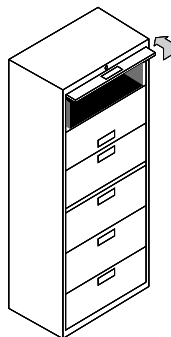

The bottom drawer of all the file cabinets is manufactured with a fixed front (even when the file cabinet is specified with receding doors).

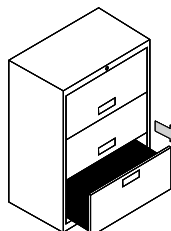

Shelf

The option of the posting shelf applies to file cabinets with 4 to 6 drawers and replaces the reinforced crossbar. Depending on the type of configuration selected, it can be situated at 30", 33" or 36" from the bottom. To replace the reinforced crossbar, add the code RS under "Options". Upcharge of \$127. Certain restrictions will apply, see the product description.

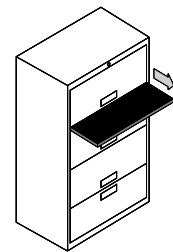

File Bars

The metal lateral file cabinets are delivered with side-to-side lateral file bars for each 12" drawer. This allows for both letter and legal size documents. For front-to-back filing, the bars must be ordered separately (as shown on see p.66).

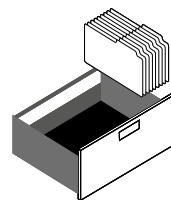

Lateral file bars (included).

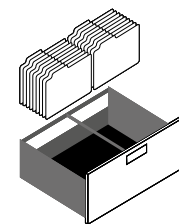

Front-to-back lateral file bars (order separately).

Interlock

Interlock is a blocking mechanism that allows the opening of only a single drawer at a time to prevent the filing unit from tipping over.

Storage specifications (cont'd)

Counterweight

The counterweight option is available on certain products. This counterweight is installed in the factory and reduces the chance of tipping when overloading the upper drawers. To meet with BIFMA standards, please call Artopex Customer Service.

Metal Colors

The metal units are available in all of the finishes on the current Artopex enamel color sample cards. Please note that the Metallic colors are in a different price category than standard colors, as shown in the price list.

Shelves in the overfile cabinets, storage cabinets and bookcases are color-matched with the exterior finish. All accessories are black unless otherwise indicated.

Laminate and Wood Finishes

Laminated or wood tops are available for lateral files, see the Take Off and Essentia price lists. Refer to the current Artopex laminate and wood finishes sample cards.

Non Standard Colors

To order products finished in colors not appearing on the current Artopex enamel sample cards, proceed as follows:

1. Prepare a list with descriptions of the product required.
 2. Add the code "90XX" in the "color" section of the specification line and identify, if necessary, the sections of the unit to be painted in this colour.
 3. Send pre-paid a 4"x6" sample to Artopex Customer Service: **Artopex, 800 Vadnais, Granby, Qc, Canada, J2J 1A7.**
- If possible, indicate the name of the paint supplier and/or a product reference.
4. Add a net amount of \$1,000 per order and per color for a quantity of 1 to 20 metal products or \$1,500 for more than 21 metal products.

Certain colors, including shades of white, may be difficult to match. Artopex will submit a sample as close as possible to the requested color for approval. The delivery date is 4 to 6 weeks from the date the sample is returned, approved and signed by the client.

Express

Artopex offers certain products on a ready-to-ship basis. The  logo in front of the product code will identify them in the price list. Refer to our Express program for more details (colors, delivery dates, etc.).

C.O.M. Orders (cushions)

Clients can order Artopex cushions covered in fabric supplied by the client. The base price of the products are equal to Grade 2, indicated in the second column of the price chart (COM/Gr.2)

C.O.M. orders must be clearly written, indicating the color, the pattern, the size of the fabric and the name of the manufacturer or distributor. Request the appropriate form from Artopex Customer Service.

If requested by Customer Service, a 12"x12" sample must be sent, pre-paid, to Artopex Customer Service for approval: **Artopex, 800 Vadnais, Granby, Qc, Canada, J2J 1A7.**

Once the sample and the order have been approved, Customer Service will provide instructions for the delivery of the fabric to our plants.

When the fabric is supplied by the client, the order delivery date will be confirmed only after the material is received at Artopex. Artopex accepts no responsibility with regard to the quality and durability of fabric that is not part of its regular fabric offering.

Complements

The drawers can be equipped with compressors, different types of dividers, card trays, etc. Order these items separately.

General Information

- Artopex reserves the right to modify the specifications of products, materials, design or accessories without notice. Artopex also reserves the right to discontinue products.
- Products, accessories, materials and finishes as described in the price lists prevail over the content of brochures or flyers.
- The weights and volumes shown in the price lists include packaging and are approximate.

Finish choices chart

Metal		
Abyss 3113	Eggshell 3005	Polar White 3002
Amber 3108	Espresso 3076	Poppy 3110
Antique White 3004	Fossil 3102	Sand 3009
Ashen 3370**	Frost 3065	Shadow 3101
Black 3067	Grenadine 3044	Silver 3090*
Cactus 3105	Grey 3063	Smoothie 3109
Champagne 3311**	Lemon 3104	Source 3106
Charcoal 3064	Mimosa 3114	Suede 3023
Cherry 3111	Moka 3075	Tangerine 3020
China Blue 3048	Navy 3050	Warm Grey 3061

* Standard prices

** Metallic prices

Refer to the current Artopex metal card.

Locks

NOKI Electronic Lock

Master keys for the Noki electronic lock are available in the Accessories price list.

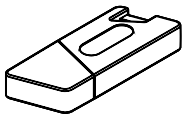

The NOKI lock is offered as an option on most metal storage. It is possible to specify the position of the lock on the lateral files: assign "LT1" for a lock positioned at the top of the cabinet and "LM1" for a lock positioned at mid-height, 36" H.

The Noki lock is compliant with ANSI / BIFMA standards.



Standard Lock

All of the cabinets (except bookcases and overfiles) include a locking system of one to three locks in a chrome finish.

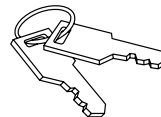

Keyed Alike

The option to key alike is available, without upcharge, on all of the products with standard locks. Keyed alike products must be grouped and identified as such. Assign code **K01** for the parts in the first workstation, **K02** for the parts of the second workstation, and so on. Unless otherwise specified, the locks will be installed in the factory with a lock number associated with code K_ _ .

ATTENTION:
Random lock numbers will be used for each order. Therefore, it is necessary to specify the key number when ordering additional keys.

Noki - positions on the units

The position of the standard lock is indicated in the illustrations in the price list.
The illustrations below show the position of the Noki electronic locks, when the option is selected.

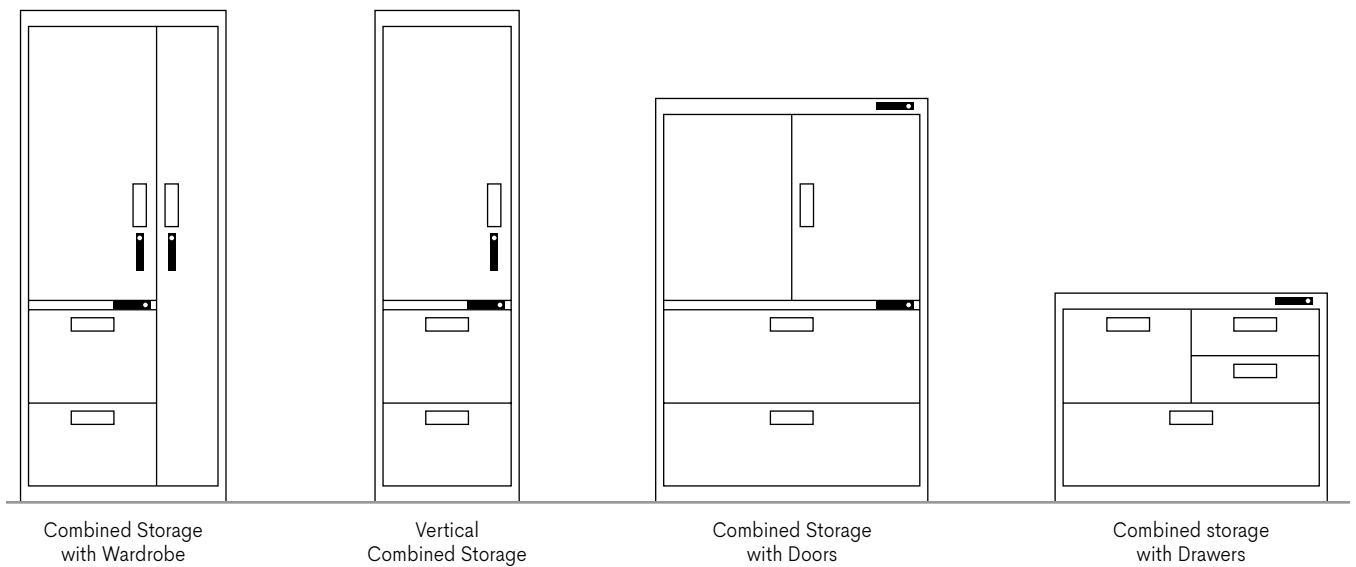
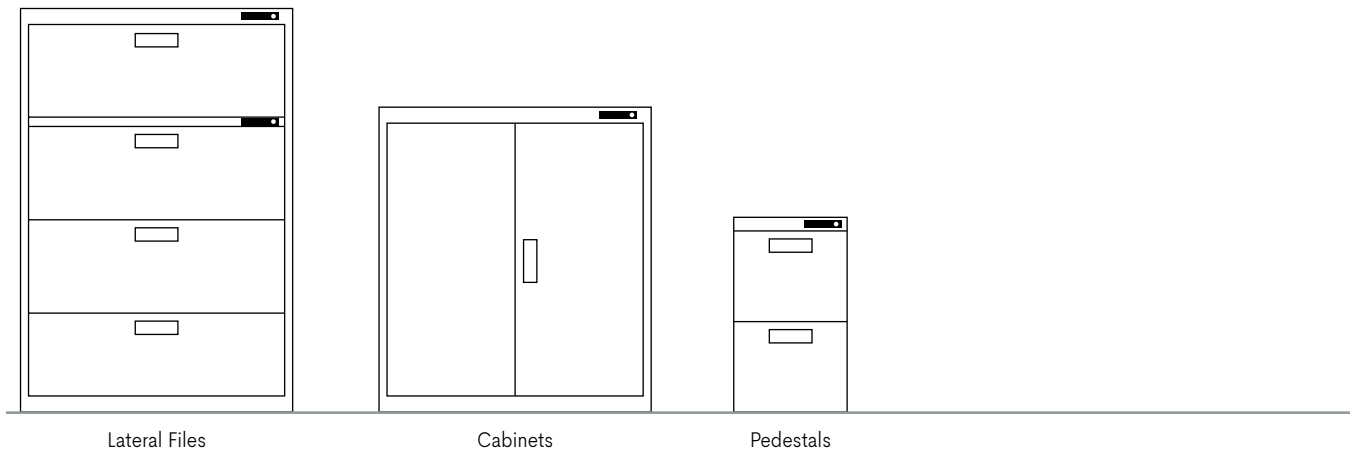

Pedestals

General information

The pedestals are modular 15" wide units and are compatible with the Artopex furniture and systems. They are available in three heights on levelling glides or on double-wheel casters.

All pedestals are supplied with a standard lock. The keyed alike or a Noki electronic lock options are available.

Each pedestal includes a pencil tray in the first 3" or 6" drawer, a divider in each 3" and 6" drawer and 2 suspension bars in all 12" drawers.

Mobile pedestals have an additional caster installed under the bottom drawer for extra stability.







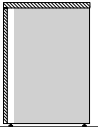
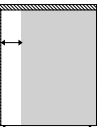

The drawers use full-extension ball bearing slides, allowing complete opening and smooth operation. 3", 6" and 12" H. drawers are available.

Horizontal clearance under surfaces

The chart (on right) shows the clearance available under the desks and tables of the Take Off series, when a metal storage unit is positioned under the work surface.

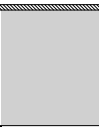
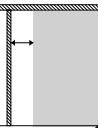
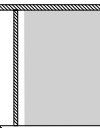
Vertical clearance under surfaces

The chart (below) shows the vertical space use when a metal storage unit is placed under a 29" H. surface.

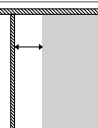
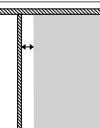
Surface depth with modesty	Metal storage depth		
	18"	22"	28"
18"	Does not fit	Does not fit	Does not fit
21"	 2 1/4" space	Does not fit	Does not fit
24"	 5 1/4" space	 1 1/4" space	Does not fit
30"	 11 1/4" space	 7 1/4" space	 1 1/4" space
30" (5" recessed modesty panel)	 6 3/8" space	 2 3/8" space	Does not fit
36"	 17 1/4" space	 13 1/4" space	 7 1/4" space
36" (11" recessed modesty panel)	 6 3/8" space	 2 3/8" space	Does not fit

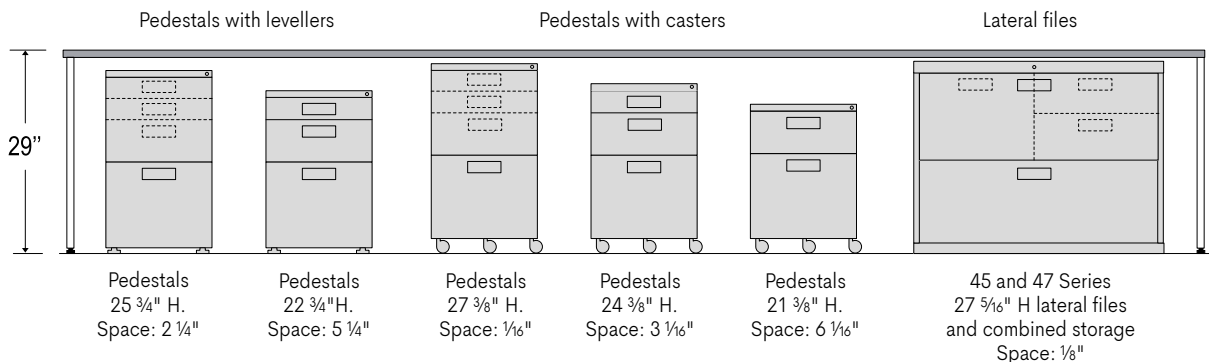

Compact mobile pedestals

General information

The pedestals are modular on casters and are 11 13/16" and 15 3/8" wide units. They are compatible with Artopex furniture and systems. They are available in two heights.

All pedestals are supplied with a Noki electronic lock.

Compact mobile pedestals have an additional caster installed under the bottom drawer for extra stability.

The drawers use full-extension ball bearing slides, allowing complete opening and smooth operation. The utility drawer measures 4 11/16" H. and the file drawer measures 11 1/16" H.

Horizontal clearance under surfaces

The chart (on the right) shows the clearance available under desks and tables of the Take Off series, when a metal storage unit is positioned under the work surface.

Vertical clearance under surfaces

The chart (below) shows the vertical space used when a metal storage unit is placed under a 29" H. surface.

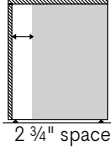
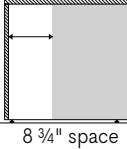
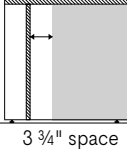
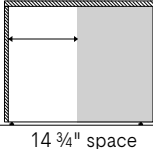
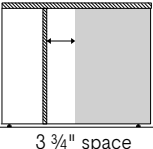
Surface depth	Metal storage depth
	20 1/2"
18"	Does not fit
21"	Does not fit
24"	 2 3/4" space
30"	 8 3/4" space
30" (5" recessed modesty panel)	 3 3/4" space
36"	 14 3/4" space
36" (11" recessed modesty panel)	 3 3/4" space

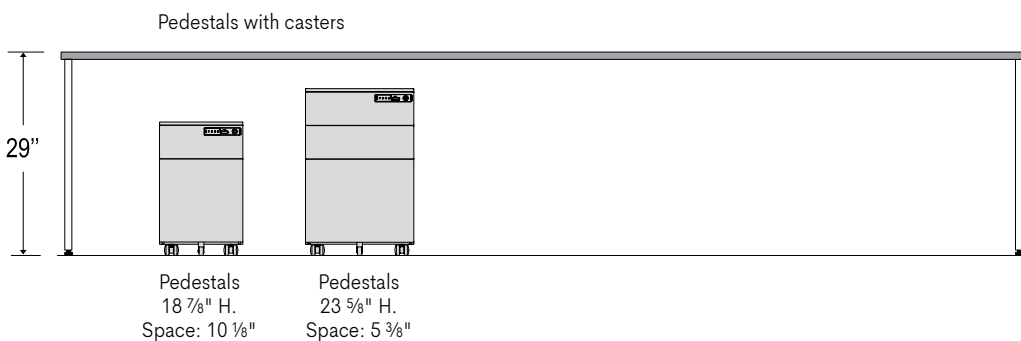

Lateral files

It is possible to customize a file cabinet in the 55 and 57 Series by specifying the number and type of drawer along with the style of cabinet requested. The information below summarizes the different options. Other types outside of the standards can be manufactured depending on the request. Please speak with your representative or Artopex Customer Service for more information on the conditions and the way to order a custom file cabinet.

Types and styles of drawers

There are 4 types of drawers/shelves offered in different height formats and in 3 sizes: 30", 36" and 42". The 3" drawers have 2 dividers and cannot be locked with a key regardless of their position on the cabinet.

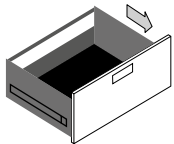

Drawer with fixed front

Offered in heights:
 3" (code E)
 6" (code 0)
 9" (code 9)
 12" (code 3)
 15" (code 7)

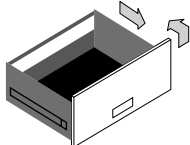

Drawer with receding door with sliding shelf

Offered in heights:
 12" (code 1)
 15" (code 5)

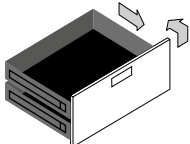

Drawer with receding door with double sliding shelf

Offered in heights:
 12" (code 4)
 15" (code 5)

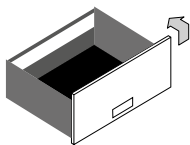

Drawer with receding door with fixed shelf

Offered in heights:
 12" (code 2)
 15" (code 6)

ATTENTION:
the 3" drawers are not available in the 57 Series.

Case format

When ordering a custom cabinet, it is important to confirm that the heights of the drawers correspond to the vertical capacity of the case. For the case of the file cabinets, there are 5 heights and 3 widths: 30", 36" and 42".

All of the cases are equipped with levellers, an Interlock mechanism and a standard lock, [see p.15](#).

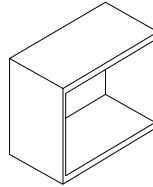

24" H.

Offered in these widths:
 30", 36" and 42"

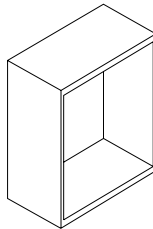

36" H.

Offered in these widths:
 30", 36" and 42"

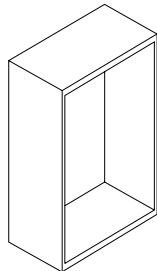

48" H.

Offered in these widths:
 30", 36" and 42"

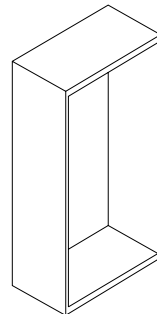

60" H.

Offered in these widths:
 30", 36" and 42"

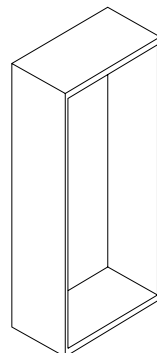

72" H.

Offered in these widths:
 30" and 36"

Examples of custom cabinets

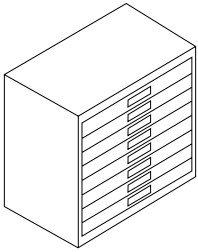

24" H. Case
8x 3" drawers

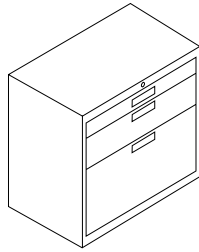

24" H. Case
3" drawer
6" drawer
15" drawer

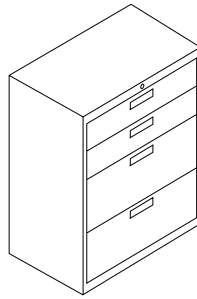

36" H. Case
2x 6" drawers
2x 12" drawers

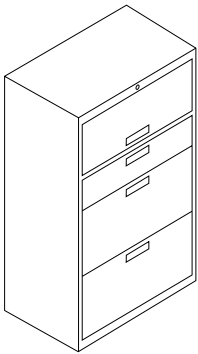

48" H. Case
12" drawer
6" drawer
2x 15" drawers

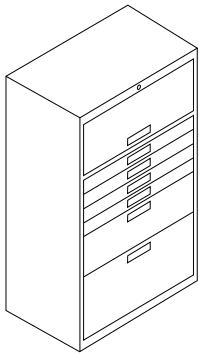

48" H. Case
12" drawer
4x 3" drawers
9" drawer
15" drawer

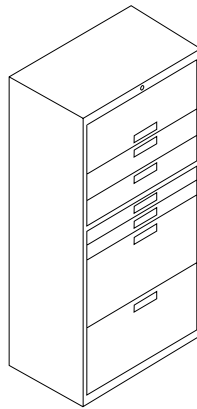

60" H. Case
12" drawer
2x 6" drawers
2x 3" drawers
2x 5" drawers

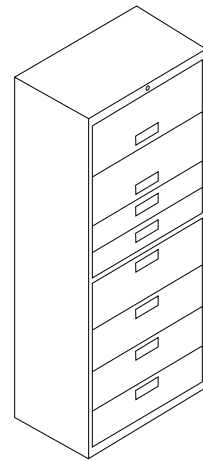

72" H. Case
2x 12" drawers
2x 6" drawers
4x 9" drawers

Specification examples

Examples of specification codes assigned to different products:

4-DRAWER LATERAL FILE

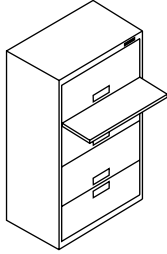

S SPECIFY		O OPTIONS		
Code	Color	Shelf	C-Weight	Lock
45-41-036-3333	3002	RS	1CW	LT1

Product: 4-drawer lateral file, 36" wide, 45 Series, fixed fronts.

Color: Polar White 3002

Shelf option: shelf added

Counterweight option: counterweight added

Lock option: NOKI electronic lock added

Order code:

45-41-036-3333-3002-RS-1CW-LT1

6-DRAWER LATERAL FILE

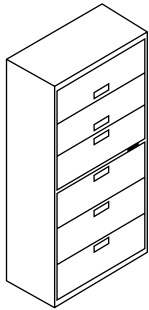

S SPECIFY		O OPTIONS		
Code	Color	Shelf	C-Weight	Lock
55-61-036-211113	3090		1CW	LM1

Product: 6-drawer lateral file, 36" wide, 55 Series, receding doors.

Color: Silver 3090

Counterweight option: counterweight added

Lock option: NOKI electronic lock added, positioned at mid-height.

Order code:

55-61-036-211113-3090-1CW-LM1

MOBILE PEDESTAL

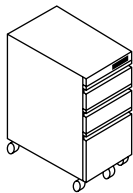

S SPECIFY		O OPTIONS	
Code	Color	C-Weight	Lock
MP47-22-6612CA	3064	1CW	LT1

Product: mobile pedestal, 22" deep, 6612, 47 Series.

Color: Charcoal 3064

Counterweight option: counterweight added

Lock option: NOKI electronic lock added

Order code:

MP47-22-6612CA-3064-1CW-LT1

CUSHION

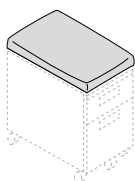

S SPECIFY	
Code	Fabric
AC - AC-CUS1518	CM02

Product: cushion 18" deep.

Fabric: Black leather.

Order code:

AC-CUS1518-CM02

Lateral files



2-drawers lateral files - with fixed fronts

Lateral file cabinet with 2 - 12" drawers.

Lateral filing bars included.

Lock & key included. Keyed-alike or NOKI lock available as an option.

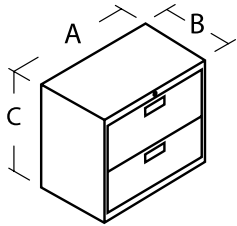
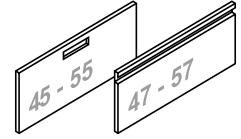

Dimensions				Code	Price		Spec.	
A	B	C	Series		Standard	Metallic	Cu.Ft	lb
WIDTH 30"								
30	18	27 15/16	55	55-21-030-33	1069	1135	10.0	93
30	18	27 15/16	57	57-21-030-33	1131	1197	10.0	93
WIDTH 36"								
36	18	27 15/16	45	45-21-036-33	845	911	12.2	100
36	18	27 15/16	47	47-21-036-33	911	977	12.2	100
36	18	27 15/16	55	55-21-036-33	1115	1181	12.2	108
36	18	27 15/16	57	57-21-036-33	1176	1242	12.2	108
WIDTH 42"								
42	18	27 15/16	55	55-21-042-33	1203	1269	14.4	125
42	18	27 15/16	57	57-21-042-33	1266	1332	14.4	125

S SPECIFY

Code Color C-Weight Lock

- - -

O OPTIONS

S Code: Consult the product code above.

Color: Specify the enamel finish, refer to the current Artopex enamel sample color cards. For metallic colors, refer to the "Metallic" column for pricing.

O Counterweight: To add a counterweight, code (2CW), add \$229.

Lock: • Keyed-alike option, with no charge: Specify **K01** to the components of the first group, **K02** to the components of the second group and so on, [see p. 15](#).

• Noki electronic lock option (**LT1**) offered without upcharge, [see p. 15](#).

2-drawers lateral files - with receding doors

Lateral file cabinet with 3 - 12" drawers.
 Lateral filing bars included.
 Lock & key included. Keyed-alike or NOKI lock available as an option.
 Bottom drawer with fixed front.

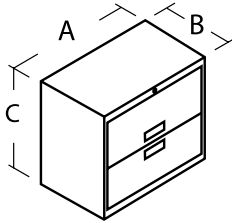
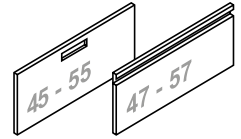

LATERAL FILES

Dimensions				Code	Price		Spec.	
A	B	C	Series		Standard	Metallic	Cu.Ft	lb
WIDTH 30"								
30	18	27 15/16	55	55-21-030-13	1099	1165	10.0	93
30	18	27 15/16	57	57-21-030-13	1163	1229	10.0	93
WIDTH 36"								
36	18	27 15/16	45	45-21-036-13	921	987	12.2	100
36	18	27 15/16	47	47-21-036-13	984	1050	12.2	100
36	18	27 15/16	55	55-21-036-13	1148	1214	12.2	108
36	18	27 15/16	57	57-21-036-13	1209	1275	12.2	108
WIDTH 42"								
42	18	27 15/16	55	55-21-042-13	1236	1302	14.4	125
42	18	27 15/16	57	57-21-042-13	1297	1363	14.4	125

S SPECIFY

Code Color C-Weight Lock

- - -

O OPTIONS

- S Code:** Consult the product code above.
- Color:** Specify the enamel finish, refer to the current Artopex enamel sample color cards. For metallic colors, refer to the "Metallic" column for pricing.
- O Counterweight:** To add a counterweight, code (2CW), add \$229.
- Lock:**
 - Keyed-alike option, with no charge: Specify **K01** to the components of the first group, **K02** to the components of the second group and so on, [see p.15](#).
 - Noki electronic lock option (**LT1**) offered without upcharge, [see p.15](#).

3-drawers lateral files - with fixed fronts

Lateral file cabinet with 3 - 12" drawers.

Lateral filing bars included.

Lock & key included. Keyed-alike or NOKI lock available as an option.

◊ Lateral file available as an Express product, add (K) in front of product code, see p. 14.

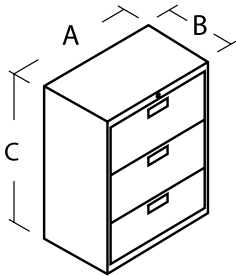
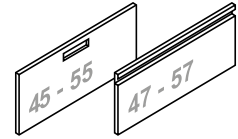

Dimensions				Code	Price		Spec.	
A	B	C	Series		Standard	Metallic	Cu.Ft	lb
WIDTH 30"								
30	18	40 1/6	55	55-31-030-333	1369	1469	14.4	132
30	18	40 1/6	57	57-31-030-333	1441	1541	14.4	132
WIDTH 36"								
36	18	40 1/6	◊ 45	45-31-036-333	1116	1216	17.3	129
36	18	40 1/6	47	47-31-036-333	1188	1288	17.3	129
36	18	40 1/6	55	55-31-036-333	1424	1524	17.3	147
36	18	40 1/6	57	57-31-036-333	1497	1597	17.3	147
WIDTH 42"								
42	18	40 1/6	55	55-31-042-333	1560	1660	20.4	171
42	18	40 1/6	57	57-31-042-333	1634	1734	20.4	171

S SPECIFY

Code Color C-Weight Lock

- - -

O OPTIONS

S Code: Consult the product code above.

Color: Specify the enamel finish, refer to the current Artopex enamel sample color cards. For metallic colors, refer to the "Metallic" column for pricing.

O Counterweight: To add a counterweight, code (1CW), add \$114.

Lock: • Keyed-alike option, with no charge: Specify **K01** to the components of the first group, **K02** to the components of the second group and so on, see p. 15.

• Noki electronic lock option (**LT1**) offered without upcharge, see p. 15.

3-drawers lateral files - with receding doors

Lateral file cabinet with 3 - 12" drawers.
 Lateral filing bars included.
 Lock & key included. Keyed-alike or NOKI lock available as an option.
 Bottom drawer with fixed front.

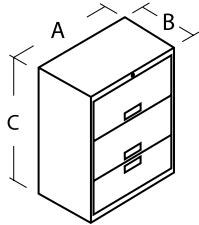
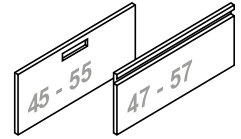

LATERAL FILES

Dimensions				Code	Price		Spec.	
A	B	C	Series		Standard	Metallic	Cu.Ft	lb
WIDTH 30"								
30	18	40 1/6	55	55-31-030-113	1430	1530	14.4	132
30	18	40 1/6	57	57-31-030-113	1503	1603	14.4	132
WIDTH 36"								
36	18	40 1/6	45	45-31-036-113	1233	1333	17.3	129
36	18	40 1/6	47	47-31-036-113	1306	1406	17.3	129
36	18	40 1/6	55	55-31-036-113	1486	1586	17.3	147
36	18	40 1/6	57	57-31-036-113	1558	1658	17.3	147
WIDTH 42"								
42	18	40 1/6	55	55-31-042-113	1623	1723	20.4	171
42	18	40 1/6	57	57-31-042-113	1696	1796	20.4	171

S SPECIFY

Code Color C-Weight Lock

- - -

O OPTIONS

- S Code:** Consult the product code above.
- Color:** Specify the enamel finish, refer to the current Artopex enamel sample color cards. For metallic colors, refer to the "Metallic" column for pricing.
- O Counterweight:** To add a counterweight, code **(1CW)**, add \$114.
- Lock:**
 - Keyed-alike option, with no charge: Specify **K01** to the components of the first group, **K02** to the components of the second group and so on, [see p. 15](#).
 - Noki electronic lock option **(LT1)** offered without upcharge, [see p. 15](#).

4-drawers lateral files - with fixed fronts

Lateral file cabinet with 4 - 12" drawers.

Lateral filing bars included.

Lock & key included. Keyed-alike or NOKI lock available as an option.

◊ Lateral file available as an Express product, add (K) in front of product code, see p.14.

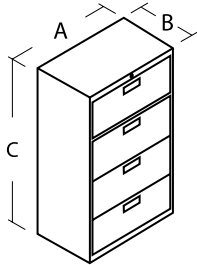
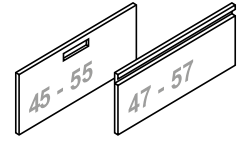

Dimensions				Code	Price		Spec.	
A	B	C	Series		Standard	Metallic	Cu.Ft	lb
WIDTH 30"								
30	18	53 3/8	55	55-41-030-3333	1707	1840	18.9	175
30	18	53 3/8	57	57-41-030-3333	1808	1941	18.9	175
WIDTH 36"								
36	18	53 3/8	◊ 45	45-41-036-3333	1406	1539	22.9	169
36	18	53 3/8	47	47-41-036-3333	1509	1642	22.9	169
36	18	53 3/8	55	55-41-036-3333	1770	1903	22.9	193
36	18	53 3/8	57	57-41-036-3333	1870	2003	22.9	193
WIDTH 42"								
42	18	53 3/8	55	55-41-042-3333	1883	2016	26.9	220
42	18	53 3/8	57	57-41-042-3333	1982	2115	26.9	220

S SPECIFY

Code Color Shelf C-Weight Lock

- - - -

O OPTIONS

S Code: Consult the product code above.

Color: Specify the enamel finish, refer to the current Artopex enamel sample color cards. For metallic colors, refer to the "Metallic" column for pricing.

O Shelf: Posting shelf over the 3rd drawer, assign code (RS), add \$127, see p.13.

Counterweight: To add a counterweight, code (1CW), add \$114.

Lock: • Keyed-alike option, with no charge: Specify **K01** to the components of the first group, **K02** to the components of the second group and so on, see p.15.

• Noki electronic lock located at top of cabinet (**LT1**) or at mid-height - 36" H. (**LM1**). Option offered without upcharge, see p.15.

4-drawers lateral files - with receding doors

Lateral file cabinet with 4 - 12" drawers.
 Lateral filing bars included.
 Lock & key included. Keyed-alike or NOKI lock available as an option.
 Bottom drawer with fixed front.

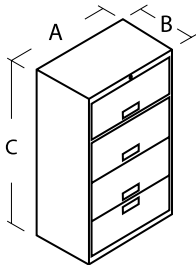
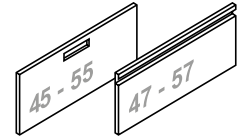

LATERAL FILES

Dimensions				Code	Price		Spec.	
A	B	C	Series		Standard	Metallic	Cu.Ft	lb
WIDTH 30"								
30	18	53 3/8	55	55-41-030-1113	1806	1939	18.9	175
30	18	53 3/8	57	57-41-030-1113	1905	2038	18.9	175
WIDTH 36"								
36	18	53 3/8	45	45-41-036-1113	1605	1738	22.9	169
36	18	53 3/8	47	47-41-036-1113	1675	1808	22.9	169
36	18	53 3/8	55	55-41-036-1113	1867	2000	22.9	193
36	18	53 3/8	57	57-41-036-1113	1969	2102	22.9	193
WIDTH 42"								
42	18	53 3/8	55	55-41-042-1113	1978	2111	26.9	220
42	18	53 3/8	57	57-41-042-1113	2080	2213	26.9	220

S SPECIFY

O OPTIONS

Code Color Shelf C-Weight Lock

- - - -

- S Code:** Consult the product code above.
- Color:** Specify the enamel finish, refer to the current Artopex enamel sample color cards. For metallic colors, refer to the "Metallic" column for pricing.
- O Shelf:** Posting shelf over the 3rd drawer, assign code (RS), add \$127, [see p.13](#).
- Counterweight:** To add a counterweight, code (1CW), add \$114.
- Lock:**
 - Keyed-alike option, with no charge: Specify **K01** to the components of the first group, **K02** to the components of the second group and so on, [see p.15](#).
 - Noki electronic lock located at top of cabinet (**LT1**) or at mid-height - 36" H. (**LM1**). Option offered without upcharge, [see p.15](#).

5-drawers lateral files - with fixed fronts

Lateral file cabinet with 5 - 12" drawers.
 Lateral filing bars included.
 Lock & key included. Keyed-alike or NOKI lock available as an option.
 Top drawer with receding door and a posting shelf.

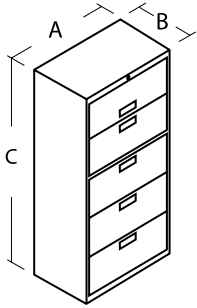
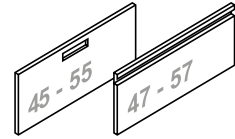

Dimensions				Code	Price		Spec.	
A	B	C	Series		Standard	Metallic	Cu.Ft	lb
WIDTH 30"								
30	18	65 ½	55	55-51-030-13333	2115	2282	22.8	212
30	18	65 ½	57	57-51-030-13333	2242	2409	22.8	212
WIDTH 36"								
36	18	65 ½	45	45-51-036-13333	1746	1913	27.9	207
36	18	65 ½	47	47-51-036-13333	1874	2041	27.9	207
36	18	65 ½	55	55-51-036-13333	2207	2374	27.9	231
36	18	65 ½	57	57-51-036-13333	2329	2496	27.9	231
WIDTH 42"								
42	18	65 ½	55	55-51-042-13333	2506	2673	33.0	268
42	18	65 ½	57	57-51-042-13333	2629	2796	33.0	268

LATERAL FILES

S SPECIFY

Code Color Shelf C-Weight Lock

- - - -

O OPTIONS

- S Code:** Consult the product code above.
- Color:** Specify the enamel finish, refer to the current Artopex enamel sample color cards. For metallic colors, refer to the "Metallic" column for pricing.
- O Shelf:** Posting shelf over the 3rd drawer, assign code **(RS)**, add \$127, *see p.13*.
- Counterweight:** To add a counterweight, code **(1CW)**, add \$114.
- Lock:**
 - Keyed-alike option, with no charge: Specify **K01** to the components of the first group, **K02** to the components of the second group and so on, *see p.15*.
 - Noki electronic lock located at top of cabinet **(LT1)** or at mid-height - 36" H. **(LM1)**. Option offered without upcharge, *see p.15*.

5-drawers lateral files - with receding doors

Lateral file cabinet with 5 - 12" drawers.
 Lateral filing bars included.
 Lock & key included. Keyed-alike or NOKI lock available as an option.
 Bottom drawer with fixed front.

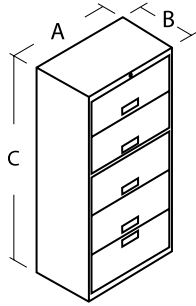
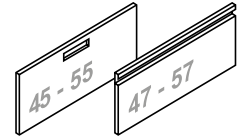

LATERAL FILES

Dimensions				Code	Price		Spec.	
A	B	C	Series		Standard	Metallic	Cu.Ft	lb
WIDTH 30"								
30	18	65 ½	55	55-51-030-11113	2191	2358	22.8	212
30	18	65 ½	57	57-51-030-11113	2313	2480	22.8	212
WIDTH 36"								
36	18	65 ½	45	45-51-036-11113	1902	2069	27.9	207
36	18	65 ½	47	47-51-036-11113	2028	2195	27.9	207
36	18	65 ½	55	55-51-036-11113	2282	2449	27.9	231
36	18	65 ½	57	57-51-036-11113	2403	2570	27.9	231
WIDTH 42"								
42	18	65 ½	55	55-51-042-11113	2581	2748	33.0	268
42	18	65 ½	57	57-51-042-11113	2705	2872	33.0	268

S SPECIFY

O OPTIONS

Code Color Shelf C-Weight Lock

- - - -

- S Code:** Consult the product code above.
- Color:** Specify the enamel finish, refer to the current Artopex enamel sample color cards. For metallic colors, refer to the "Metallic" column for pricing.
- O Shelf:** Posting shelf over the 3rd drawer, assign code **(RS)**, add \$127, [see p.13](#).
- Counterweight:** To add a counterweight, code **(1CW)**, add \$114.
- Lock:**
 - Keyed-alike option, with no charge: Specify **K01** to the components of the first group, **K02** to the components of the second group and so on, [see p.15](#).
 - Noki electronic lock located at top of cabinet **(LT1)** or at mid-height - 36" H. **(LM1)**. Option offered without upcharge, [see p.15](#).

6-drawers lateral files - with fixed fronts

Lateral file cabinet with 5 - 12" drawers.

Lateral filing bars included.

Lock & key included. Keyed-alike or NOKI lock available as an option.

Top drawer with receding door and a fixed shelf.

Second drawer from top with receding door and a posting shelf.

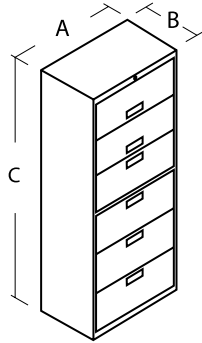
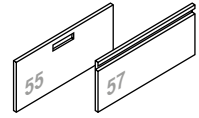

Dimensions				Code	Price		Spec.	
A	B	C	Series		Standard	Metallic	Cu.Ft	lb
WIDTH 30"								
30	18	77 5/8	55	55-61-030-213333	2633	2834	28.0	260
30	18	77 5/8	57	57-61-030-213333	2826	3027	28.0	260
WIDTH 36"								
36	18	77 5/8	55	55-61-036-213333	2633	2834	33.0	280
36	18	77 5/8	57	57-61-036-213333	2826	3027	33.0	280

S SPECIFY

Code Color Shelf C-Weight Lock

- - - -

O OPTIONS

S **Code:** Consult the product code above.

Color: Specify the enamel finish, refer to the current Artopex enamel sample color cards. For metallic colors, refer to the "Metallic" column for pricing.

O **Shelf:** Posting shelf over the 3rd drawer, assign code **(RS)**, add \$127, [see p.13](#).

Counterweight: To add a counterweight, code **(1CW)**, add \$114.

Lock: • Keyed-alike option, with no charge: Specify **K01** to the components of the first group, **K02** to the components of the second group and so on, [see p.15](#).

• Noki electronic lock located at top of cabinet **(LT1)** or at mid-height - 36" H. **(LM1)**. Option offered without upcharge, [see p.15](#).

6-drawers lateral files - with receding doors

Lateral file cabinet with 5 - 12" drawers.
 Lateral filing bars included.
 Lock & key included. Keyed-alike or NOKI lock available as an option.
 Bottom drawer with fixed front.
 Top drawer with receding door and a fixed work shelf.

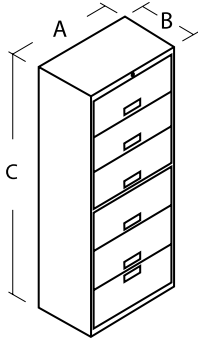
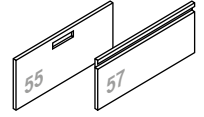

Dimensions			Code		Price		Spec.	
A	B	C	Series		Standard	Metallic	Cu.Ft	lb
WIDTH 30"								
30	18	77 5/8	55	55-61-030-211113	2711	2912	28.0	260
30	18	77 5/8	57	57-61-030-211113	2904	3105	28.0	260
WIDTH 36"								
36	18	77 5/8	55	55-61-036-211113	2711	2912	33.0	280
36	18	77 5/8	57	57-61-036-211113	2904	3105	33.0	280

S SPECIFY

Code Color Shelf C-Weight Lock

- - - -

O OPTIONS

- S Code:** Consult the product code above.
- Color:** Specify the enamel finish, refer to the current Artopex enamel sample color cards. For metallic colors, refer to the "Metallic" column for pricing.
- O Shelf:** Posting shelf over the 3rd drawer, assign code **(RS)**, add \$127, [see p.13](#).
- Counterweight:** To add a counterweight, code **(1CW)**, add \$114.
- Lock:**
 - Keyed-alike option, with no charge: Specify **K01** to the components of the first group, **K02** to the components of the second group and so on, [see p.15](#).
 - Noki electronic lock located at top of cabinet **(LT1)** or at mid-height - 36" H. **(LM1)**. Option offered without upcharge, [see p.15](#).

Combined storage



Combined storage - with drawers

Combined lateral file with 1 - 12" filing drawer, with 2 - 6" drawers and 1 - 12" drawer.

Lateral filing bars included.

Lock & key included. Keyed-alike or NOKI lock available as an option.

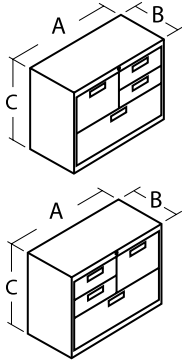
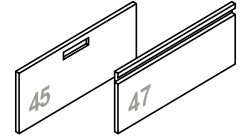

Dimensions			Code	Price		Spec.		
A	B	C	Series	Standard	Metallic	Cu.Ft	lb	
6" DRAWERS ON RIGHT								
36	18	27 7/8	45	45-21-036-FUU3	1474	1540	12.2	100
36	18	27 7/8	47	47-21-036-FUU3	1533	1599	12.2	100
6" DRAWERS ON LEFT								
36	18	27 7/8	45	45-21-036-UUF3	1474	1540	12.2	100
36	18	27 7/8	47	47-21-036-UUF3	1533	1599	12.2	100

S SPECIFY

Code Color C-Weight Lock

- - -

O OPTIONS

S Code: Consult the product code above.

Color: Specify the enamel finish, refer to the current Artopex enamel sample color cards. For metallic colors, refer to the "Metallic" column for pricing.

O Counterweight: To add a counterweight, code (1CW), add \$114.

Lock: • Keyed-alike option, with no charge: Specify **K01** to the components of the first group, **K02** to the components of the second group and so on, [see p.15](#).

• Noki electronic lock option (**LT1**) offered without upcharge, [see p.15](#).

Combined storage - with doors

Combined lateral cabinet with 2 or 3 - 12" file drawers.
 Lateral filing bars included.
 Lock & key included. Keyed-alike or NOKI lock available as an option.

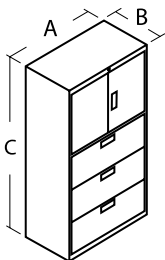
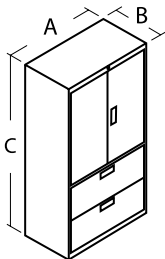
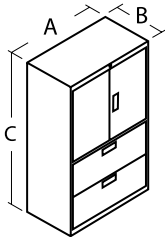
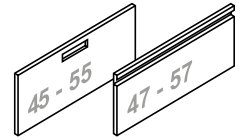

Dimensions			Code		Price		Spec.	
A	B	C	Series		Standard	Metallic	Cu.Ft	lb
1 ADJUSTABLE SHELF								
36	18	53 3/8	45	45-49-036-Y33	1961	2094	22.9	193
36	18	53 3/8	47	47-49-036-Y33	2000	2133	22.9	193
36	18	53 3/8	55	55-49-036-Y33	2028	2161	22.9	198
36	18	53 3/8	57	57-49-036-Y33	2066	2199	22.9	198
2 ADJUSTABLE SHELVES								
36	18	65 1/2	45	45-59-036-YY33	2091	2258	27.9	231
36	18	65 1/2	47	47-59-036-YY33	2157	2324	27.9	231
36	18	65 1/2	55	55-59-036-YY33	1972	2139	27.9	236
36	18	65 1/2	57	57-59-036-YY33	2233	2400	27.9	236
1 ADJUSTABLE SHELF								
36	18	65 1/2	45	45-59-036-Y333	2181	2348	27.9	231
36	18	65 1/2	47	47-59-036-Y333	2270	2437	27.9	231
36	18	65 1/2	55	55-59-036-Y333	2294	2461	27.9	236
36	18	65 1/2	57	57-59-036-Y333	2382	2549	27.9	236

COMBINED STORAGE

S SPECIFY **O OPTION**

Code Color Lock

- -

- S Code:** Consult the product code above.
- Color:** Specify the enamel finish, refer to the current Artopex enamel sample color cards. For metallic colors, refer to the "Metallic" column for pricing.
- O Lock:**
 - Keyed-alike option, with no charge: Specify **K01** to the components of the first group, **K02** to the components of the second group and so on, [see p.15](#).
 - Noki electronic lock option (**LT1**) offered without upcharge, [see p.15](#).

Combined storage - with wardrobes

Wardrobe with hanging bar.
 Cabinet with 1 shelf.
 Lock & key included. Keyed-alike or NOKI lock available as an option.
 2 - 6" drawers and 1 - 12" drawer with lateral filing bars included.

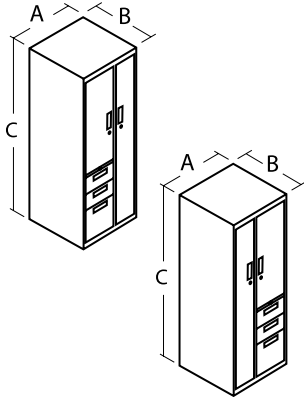
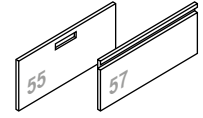

Dimensions			Code		Price		Spec.	
A	B	C	Series		Standard	Metallic	Cu.Ft	lb
WARDROBE AT RIGHT								
24	24	65 1/2	55	55-54-024-24-SRCV	2306	2439	24.9	165
24	24	65 1/2	57	57-54-024-24-SRCV	2405	2538	24.9	165
WARDROBE AT LEFT								
24	24	65 1/2	55	55-54-024-24-SLCV	2306	2439	24.9	165
24	24	65 1/2	57	57-54-024-24-SLCV	2405	2538	24.9	165

2 - 12" drawers with lateral filing bars included

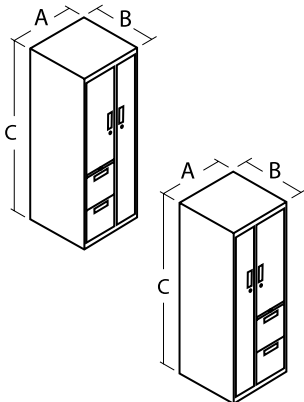

Dimensions			Code		Price		Spec.	
A	B	C	Series		Standard	Metallic	Cu.Ft	lb
WARDROBE AT RIGHT								
24	24	65 1/2	55	55-54-024-24-SRDV	2306	2439	24.9	165
24	24	65 1/2	57	57-54-024-24-SRDV	2405	2538	24.9	165
WARDROBE AT LEFT								
24	24	65 1/2	55	55-54-024-24-SLDV	2306	2439	24.9	165
24	24	65 1/2	57	57-54-024-24-SLDV	2405	2538	24.9	165

S SPECIFY

O OPTION

Code Color Lock

- -

S Code: Consult the product code above.

Color: Specify the enamel finish, refer to the current Artopex enamel sample color cards. For metallic colors, refer to the "Metallic" column for pricing.

- O Lock:**
- Keyed-alike option, with no charge: Specify **K01** to the components of the first group, **K02** to the components of the second group and so on, [see p.15](#).
 - Noki electronic lock option (**LT1**) offered without upcharge, [see p.15](#).

Combined storage - vertical

Cabinet with 1 shelf.
 2 - 6" drawers and 1 - 12" file drawer with lateral bars included.
 Lock & key included. Keyed-alike or NOKI lock available as an option.

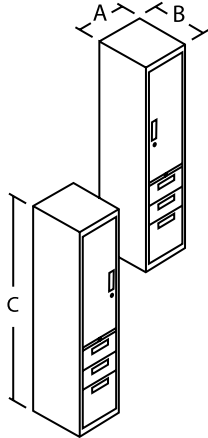
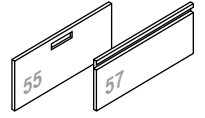

Dimensions			Code		Price		Spec.	
A	B	C	Series		Standard	Metallic	Cu.Ft	lb
DOOR HINGES AT RIGHT								
15	24	65 1/2	55	55-54-015-24-SRC	2019	2152	15.5	120
15	24	65 1/2	57	57-54-015-24-SRC	2098	2231	15.5	120
DOOR HINGES AT LEFT								
15	24	65 1/2	55	55-54-015-24-SLC	2019	2152	15.5	120
15	24	65 1/2	57	57-54-015-24-SLC	2098	2231	15.5	120

2 - 12" drawers with lateral filing bars included

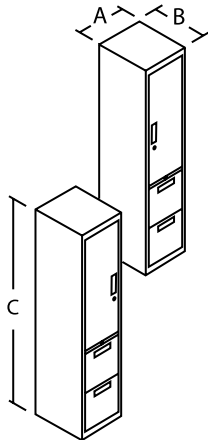

Dimensions			Code		Price		Spec.	
A	B	C	Series		Standard	Metallic	Cu.Ft	lb
DOOR HINGES AT RIGHT								
15	24	65 1/2	55	55-54-015-24-SRD	2019	2152	15.5	120
15	24	65 1/2	57	57-54-015-24-SRD	2098	2231	15.5	120
DOOR HINGES AT LEFT								
15	24	65 1/2	55	55-54-015-24-SLD	2019	2152	15.5	120
15	24	65 1/2	57	57-54-015-24-SLD	2098	2231	15.5	120

S SPECIFY **O OPTION**

Code Color Lock

- -

- S Code:** Consult the product code above.
- Color:** Specify the enamel finish, refer to the current Artopex enamel sample color cards. For metallic colors, refer to the "Metallic" column for pricing.
- O Lock:**
 - Keyed-alike option, with no charge: Specify **K01** to the components of the first group, **K02** to the components of the second group and so on, [see p.15](#).
 - Noki electronic lock option (**LT1**) offered without upcharge, [see p.15](#).

Combined storage - vertical (cont'd)

Cabinet with 1 shelf.

1 - 6" drawer and 2- 12" file drawers with lateral bars included.

Lock & key included. Keyed-alike or NOKI lock available as an option.

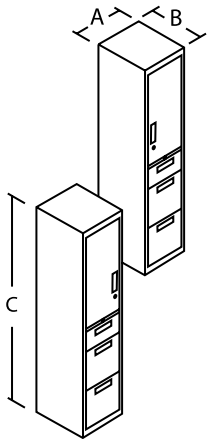
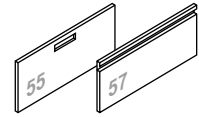

Dimensions				Code	Price		Spec.	
A	B	C	Series		Standard	Metallic	Cu.Ft	lb
DOOR HINGES AT RIGHT								
15	24	65 1/2	55	55-54-015-24-SRB	2019	2152	15.5	120
15	24	65 1/2	57	57-54-015-24-SRB	2098	2231	15.5	120
DOOR HINGES AT LEFT								
15	24	65 1/2	55	55-54-015-24-SLB	2019	2152	15.5	120
15	24	65 1/2	57	57-54-015-24-SLB	2098	2231	15.5	120

S SPECIFY

O OPTION

Code Color Lock

- -

S Code: Consult the product code above.

Color: Specify the enamel finish, refer to the current Artopex enamel sample color cards. For metallic colors, refer to the "Metallic" column for pricing.

- O Lock:**
- Keyed-alike option, with no charge: Specify **K01** to the components of the first group, **K02** to the components of the second group and so on, [see p.15](#).
 - Noki electronic lock option (**LT1**) offered without upcharge, [see p.15](#).



Pedestals with levellers

Pedestal with 2 - 12" drawers.

Lock & key included. Keyed-alike or NOKI lock available as an option.

Adjustable levellers included.

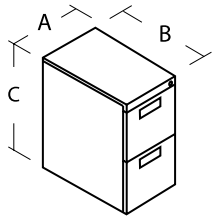
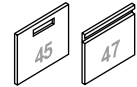

Dimensions			Code		Price		Spec.	
A	B	C	Series		Standard	Metallic	Cu.Ft	lb
DEPTH 18"								
15	18	25 3/4	45	MP45-18-1212	716	757	4.8	65
15	18	25 3/4	47	MP47-18-1212	751	792	4.8	65
DEPTH 22"								
15	22	25 3/4	45	MP45-22-1212	728	769	6.8	75
15	22	25 3/4	47	MP47-22-1212	762	803	6.8	75
DEPTH 28"								
15	28	25 3/4	45	MP45-28-1212	797	838	9.7	90
15	28	25 3/4	47	MP47-28-1212	832	873	9.7	90

Pedestal with 2 - 6" drawers and 1 - 12" drawer.

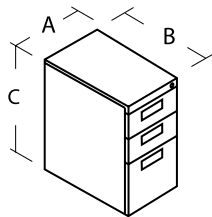

Dimensions			Code		Price		Spec.	
A	B	C	Series		Standard	Metallic	Cu.Ft	lb
DEPTH 18"								
15	18	25 3/4	45	MP45-18-6612	762	808	4.8	65
15	18	25 3/4	47	MP47-18-6612	797	843	4.8	65
DEPTH 22"								
15	22	25 3/4	45	MP45-22-6612	785	831	6.8	75
15	22	25 3/4	47	MP47-22-6612	820	866	6.8	75
DEPTH 28"								
15	28	25 3/4	45	MP45-28-6612	809	855	9.7	90
15	28	25 3/4	47	MP47-28-6612	843	889	9.7	90

S SPECIFY

Code Color C-Weight Lock

- - -

O OPTIONS

S Code: Consult the product code above.

Color: Specify the enamel finish, refer to the current Artopex enamel sample color cards. For metallic colors, refer to the "Metallic" column for pricing.

O Counterweight: To add a counterweight, code (CW), add \$147.

Lock: • Keyed-alike option, with no charge: Specify **K01** to the components of the first group, **K02** to the components of the second group and so on, [see p.15](#).

• Noki electronic lock option (**LT1**) offered without upcharge, [see p.15](#).

Pedestals with levellers (cont'd)

Pedestal with 2 - 3" drawers, 1 - 6" drawer and 1 - 12" drawer.

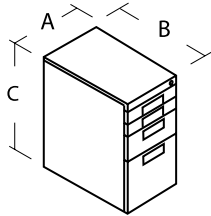

Dimensions			Code		Price		Spec.	
A	B	C	Series		Standard	Metallic	Cu.Ft	lb
DEPTH 18"								
15	18	25 3/4	45	MP45-18-33612	919	977	4.8	65
DEPTH 22"								
15	22	25 3/4	45	MP45-22-33612	942	1000	6.8	75
DEPTH 28"								
15	28	25 3/4	45	MP45-28-33612	965	1023	9.7	90

Pedestal with 1 - 3" drawer, 1 - 6" drawer and 1 - 12" drawer.

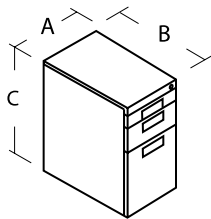

Dimensions			Code		Price		Spec.	
A	B	C	Series		Standard	Metallic	Cu.Ft	lb
DEPTH 18"								
15	18	25 3/4	45	MP45-18-3612	762	808	4.8	65
DEPTH 22"								
15	22	25 3/4	45	MP45-22-3612	785	831	6.8	75
DEPTH 28"								
15	28	25 3/4	45	MP45-28-3612	809	855	9.7	90

S SPECIFY

Code Color C-Weight Lock

- - -

O OPTIONS

S Code: Consult the product code above.

Color: Specify the enamel finish, refer to the current Artopex enamel sample color cards. For metallic colors, refer to the "Metallic" column for pricing.

O Counterweight: To add a counterweight, code (CW), add \$147.

Lock: • Keyed-alike option, with no charge: Specify **K01** to the components of the first group, **K02** to the components of the second group and so on, [see p.15](#).

• Noki electronic lock option (**LT1**) offered without upcharge, [see p.15](#).

Mobile pedestals

Pedestal with 2 - 12" drawers.

Lock & key included. Keyed-alike or NOKI lock available as an option.

5 casters included.

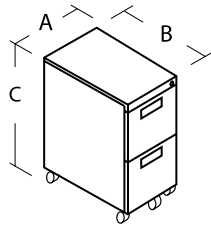
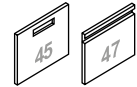

Dimensions			Code		Price		Spec.	
A	B	C	Series		Standard	Metallic	Cu.Ft	lb
DEPTH 18"								
15	18	27 3/8	45	MP45-18-1212CA	797	838	4.8	65
15	18	27 3/8	47	MP47-18-1212CA	832	873	4.8	65
DEPTH 22"								
15	22	27 3/8	45	MP45-22-1212CA	809	850	6.8	75
15	22	27 3/8	47	MP47-22-1212CA	843	884	6.8	75
DEPTH 28"								
15	28	27 3/8	45	MP45-28-1212CA	878	919	9.7	90
15	28	27 3/8	47	MP47-28-1212CA	912	953	9.7	90

Pedestal with 2 - 6" drawers and 1 - 12" drawer.

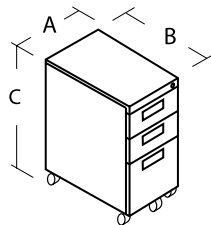

Dimensions			Code		Price		Spec.	
A	B	C	Series		Standard	Metallic	Cu.Ft	lb
DEPTH 18"								
15	18	27 3/8	45	MP45-18-6612CA	881	927	4.8	65
15	18	27 3/8	47	MP47-18-6612CA	916	962	4.8	65
DEPTH 22"								
15	22	27 3/8	45	MP45-22-6612CA	904	950	6.8	75
15	22	27 3/8	47	MP47-22-6612CA	939	985	6.8	75
DEPTH 28"								
15	28	27 3/8	45	MP45-28-6612CA	927	973	9.7	90
15	28	27 3/8	47	MP47-28-6612CA	962	1008	9.7	90

S SPECIFY

Code Color C-Weight Lock

- - -

O OPTIONS

S Code: Consult the product code above.

Color: Specify the enamel finish, refer to the current Artopex enamel sample color cards. For metallic colors, refer to the "Metallic" column for pricing.

O Counterweight: To add a counterweight, code (CW), add \$147.

Lock: • Keyed-alike option, with no charge: Specify **K01** to the components of the first group, **K02** to the components of the second group and so on, [see p.15](#).

• Noki electronic lock option (**LT1**) offered without upcharge, [see p.15](#).

Mobile pedestals (cont'd)

Pedestal with 2 - 3" drawers, 1 - 6" drawer and 1 - 12" drawer.

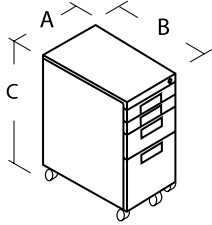

Dimensions			Code		Price		Spec.	
A	B	C	Series		Standard	Metallic	Cu.Ft	lb
DEPTH 18"								
15	18	27 3/8	45	MP45-18-33612CA	1026	1084	4.8	65
DEPTH 22"								
15	22	27 3/8	45	MP45-22-33612CA	1049	1107	6.8	75
DEPTH 28"								
15	28	27 3/8	45	MP45-28-33612CA	1072	1130	9.7	90

Pedestal with 1 - 3" drawer, 1 - 6" drawer and 1 - 12" drawer.

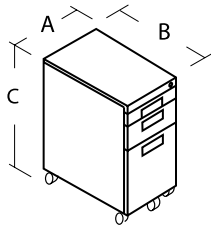

Dimensions			Code		Price		Spec.	
A	B	C	Series		Standard	Metallic	Cu.Ft	lb
DEPTH 18"								
15	18	24 3/8	45	MP45-18-3612CA	843	901	4.8	65
DEPTH 22"								
15	22	24 3/8	45	MP45-22-3612CA	866	924	6.8	75
DEPTH 28"								
15	28	24 3/8	45	MP45-28-3612CA	889	947	9.7	90

S SPECIFY **O OPTION**

Code Color Lock

- -

S Code: Consult the product code above.

Color: Specify the enamel finish, refer to the current Artopex enamel sample color cards. For metallic colors, refer to the "Metallic" column for pricing.

- O Lock:**
- Keyed-alike option, with no charge: Specify **K01** to the components of the first group, **K02** to the components of the second group and so on, [see p.15](#).
 - Noki electronic lock option (**LT1**) offered without upcharge, [see p.15](#).

Mobile pedestals (cont'd)

Pedestal with 1 - 6" drawer and 1 - 12" drawer.
 Lock & key included. Keyed-alike or NOKI lock available as an option.
 5 casters included.

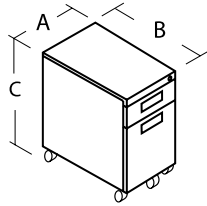
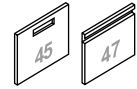

Dimensions			Code	Price		Spec.		
A	B	C	Series	Standard	Metallic	Cu.Ft	lb	
DEPTH 18"								
15	18	21 3/8	45	MP45-18-612CA	635	676	4.3	55
15	18	21 3/8	47	MP47-18-612CA	658	699	4.3	55
DEPTH 22"								
15	22	21 3/8	45	MP45-22-612CA	647	688	4.9	60
15	22	21 3/8	47	MP47-22-612CA	670	711	4.9	60

S SPECIFY

O OPTION

Code Color Lock

- -

S Code: Consult the product code above.

Color: Specify the enamel finish, refer to the current Artopex enamel sample color cards. For metallic colors, refer to the "Metallic" column for pricing.

- O Lock:**
- Keyed-alike option, with no charge: Specify **K01** to the components of the first group, **K02** to the components of the second group and so on, [see p.15](#).
 - Noki electronic lock option (**LT1**) offered without upcharge, [see p.15](#).



Compact mobile pedestals

Compact mobile pedestal with 2 utility drawers 4 1/16" H. and 1 file drawer 11 1/16" H.
 Pencil tray included in the top drawer.
 NOKI electronic lock always included.
 Available in three colors.

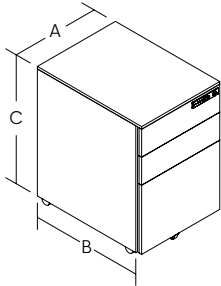

Dimensions			Color	Code	Price	Spec.	
A	B	C				Cu.Ft.	lb
15 3/8	20 1/2	23 5/8	Black	MP15UUFCA-3067-LT1	523	5.9	42
15 3/8	20 1/2	23 5/8	Silver	MP15UUFCA-3090-LT1	523	5.9	42
15 3/8	20 1/2	23 5/8	Polar White	MP15UUFCA-3002-LT1	523	5.9	42

Compact mobile pedestal with 1 utility drawer 4 1/16" H. and 1 file drawer 11 1/16" H.
 Pencil tray included in the top drawer.
 NOKI electronic lock always included.
 Available in three colors.

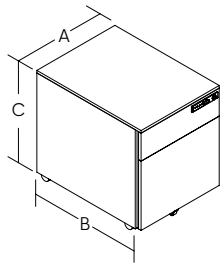

Dimensions			Color	Code	Price	Spec.	
A	B	C				Cu.Ft.	lb
15 3/8	20 1/2	18 7/8	Black	MP15UFCA-3067-LT1	495	4.8	33
15 3/8	20 1/2	18 7/8	Silver	MP15UFCA-3090-LT1	495	4.8	33
15 3/8	20 1/2	18 7/8	Polar White	MP15UFCA-3002-LT1	495	4.8	33

Compact mobile pedestal with 1 utility drawer 4 1/16" H. and 1 file drawer 11 1/16" H.
 Pencil tray included in the top drawer.
 NOKI electronic lock always included.
 Available in three colors.

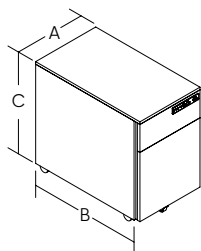

Dimensions			Color	Code	Price	Spec.	
A	B	C				Cu.Ft.	lb
11 13/16	20 1/2	18 7/8	Black	MP12UFCA-3067-LT1	468	3.9	29
11 13/16	20 1/2	18 7/8	Silver	MP12UFCA-3090-LT1	468	3.9	29
11 13/16	20 1/2	18 7/8	Polar White	MP12UFCA-3002-LT1	468	3.9	29

Felt cushion for compact mobile pedestals



Cushion made of 3/8" semi-rigid felt panel for compact mobile pedestals (MP15XX or MP12XX).
Velcro® for installation included.

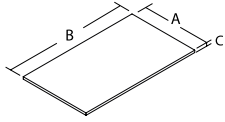

Dimensions			Code	Price	Spec.	
A	B	C			Cu.Ft.	lb
15 3/8	20 1/2	3/8	AC-CUSFMP15	66	0.1	1
11 13/16	20 1/2	3/8	AC-CUSFMP12	58	0.1	1

S SPECIFY

Code Felt

-

S Code: Consult the product code above.
Felt: Specify felt color: Mist (**FE11**) or Shadow (**FE03**).

Fabric cushion for compact mobile pedestals



Fabric cushion for compact mobile pedestals (MP15XX or MP12XX).
Velcro® for installation included.

C.O.M. Fabric - CUSMP15

0.7 v (0.65 m)

C.O.M. Fabric - CUSMP12

0.65 v (0.6 m)

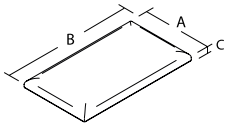

Dimensions			Code	Price					Spec.		
A	B	C		Gr.1	Gr.2/COM	Gr.3	Gr.4	Gr.5	Leather	Cu.Ft.	lb
15	20 ¼	1 ½	AC-CUSMP15	156	168	180	193	215	325	0.7	5
11 ½	20 ¼	1 ½	AC-CUSMP12	143	154	165	176	193	281	0.7	4

S SPECIFY

Code Fabric

-

S **Code:** Consult the product code above.

Fabric: Specify the fabric, refer to the current Artopex fabric sample card.

Cabinets



Cabinets - 27^{15/16}" H.

Cabinet with 1 adjustable shelf.

Finished interior construction.

Lock & key included. Keyed-alike or NOKI lock available as an option.

Extra shelves and dividers available, [see p.69](#).

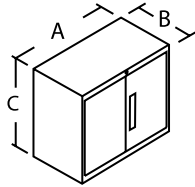
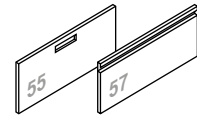

Dimensions				Code	Price		Spec.	
A	B	C	Series		Standard	Metallic	Cu.Ft	lb
WIDTH 30"								
30	18	27 ^{15/16}	55	55-28-030-Y	912	978	10.0	63
30	18	27 ^{15/16}	57	57-28-030-Y	921	987	10.0	63
WIDTH 36"								
36	18	27 ^{15/16}	55	55-28-036-Y	936	1002	12.2	70
36	18	27 ^{15/16}	57	57-28-036-Y	945	1011	12.2	70
WIDTH 42"								
42	18	27 ^{15/16}	55	55-28-042-Y	990	1056	14.4	77
42	18	27 ^{15/16}	57	57-28-042-Y	996	1062	14.4	77

S SPECIFY

O OPTION

Code Color Lock

- -

S Code: Consult the product code above.

Color: Specify the enamel finish, refer to the current Artopex enamel sample color cards. For metallic colors, refer to the "Metallic" column for pricing.

- O Lock:**
- Keyed-alike option, with no charge: Specify **K01** to the components of the first group, **K02** to the components of the second group and so on, [see p.15](#).
 - Noki electronic lock option (**LT1**) offered without upcharge, [see p.15](#).

Cabinets - 40 1/16" H.

Cabinet with 2 adjustable shelves.

Finished interior construction.

Lock & key included. Keyed-alike or NOKI lock available as an option.

Extra shelves and dividers available, [see p.69](#).

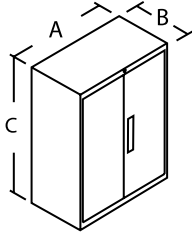
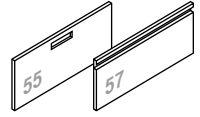

Dimensions			Code		Price		Spec.	
A	B	C	Series		Standard	Metallic	Cu.Ft	lb
WIDTH 30"								
30	18	40 1/16	55	55-38-030-YY	1078	1178	14.2	80
30	18	40 1/16	57	57-38-030-YY	1089	1189	14.2	80
WIDTH 36"								
36	18	40 1/16	55	55-38-036-YY	1104	1204	17.3	90
36	18	40 1/16	57	57-38-036-YY	1117	1217	17.3	90
WIDTH 42"								
42	18	40 1/16	55	55-38-042-YY	1169	1269	20.4	100
42	18	40 1/16	57	57-38-042-YY	1177	1277	20.4	100

S SPECIFY

O OPTION

Code Color Lock

- -

S Code: Consult the product code above.

Color: Specify the enamel finish, refer to the current Artopex enamel sample color cards. For metallic colors, refer to the "Metallic" column for pricing.

- O Lock:**
 - Keyed-alike option, with no charge: Specify **K01** to the components of the first group, **K02** to the components of the second group and so on, [see p.15](#).
 - Noki electronic lock option (**LT1**) offered without upcharge, [see p.15](#).

Cabinets - 53 3/8" H.

Cabinet with 3 adjustable shelves.

Finished interior construction.

Lock & key included. Keyed-alike or NOKI lock available as an option.

Extra shelves and dividers available, [see p.69](#).

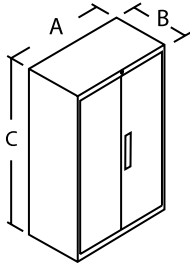
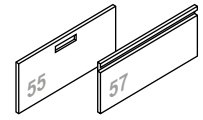

Dimensions				Code	Price		Spec.	
A	B	C	Series		Standard	Metallic	Cu.Ft	lb
WIDTH 30"								
30	18	53 3/8	55	55-48-030-YYY	1251	1384	18.9	102
30	18	53 3/8	57	57-48-030-YYY	1265	1398	18.9	102
WIDTH 36"								
36	18	53 3/8	55	55-48-036-YYY	1278	1411	22.9	115
36	18	53 3/8	57	57-48-036-YYY	1294	1427	22.9	115
WIDTH 42"								
42	18	53 3/8	55	55-48-042-YYY	1361	1494	26.9	128
42	18	53 3/8	57	57-48-042-YYY	1372	1505	26.9	128

S SPECIFY

O OPTION

Code Color Lock

- -

S Code: Consult the product code above.

Color: Specify the enamel finish, refer to the current Artopex enamel sample color cards. For metallic colors, refer to the "Metallic" column for pricing.

- O Lock:**
- Keyed-alike option, with no charge: Specify **K01** to the components of the first group, **K02** to the components of the second group and so on, [see p.15](#).
 - Noki electronic lock option (**LT1**) offered without upcharge, [see p.15](#).

Cabinets - 65 1/2" H.

Cabinet with 3 adjustable shelves.

Finished interior construction.

Lock & key included. Keyed-alike or NOKI lock available as an option.

Extra shelves and dividers available, [see p.69](#).

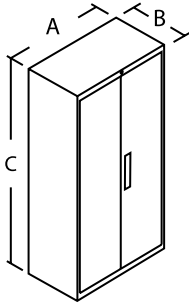
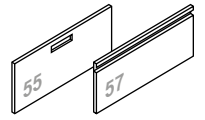

Dimensions			Code		Price		Spec.	
A	B	C	Series		Standard	Metallic	Cu.Ft	lb
WIDTH 30"								
30	18	65 1/2	55	55-58-030-YYY	1442	1609	22.8	129
30	18	65 1/2	57	57-58-030-YYY	1456	1623	22.8	129
WIDTH 36"								
36	18	65 1/2	55	55-58-036-YYY	1473	1640	27.9	145
36	18	65 1/2	57	57-58-036-YYY	1491	1658	27.9	145
WIDTH 42"								
42	18	65 1/2	55	55-58-042-YYY	1574	1741	33.0	161
42	18	65 1/2	57	57-58-042-YYY	1587	1754	33.0	161

S SPECIFY

O OPTION

Code Color Lock

- -

S Code: Consult the product code above.

Color: Specify the enamel finish, refer to the current Artopex enamel sample color cards. For metallic colors, refer to the "Metallic" column for pricing.

- O Lock:**
 - Keyed-alike option, with no charge: Specify **K01** to the components of the first group, **K02** to the components of the second group and so on, [see p.15](#).
 - Noki electronic lock option (**LT1**) offered without upcharge, [see p.15](#).

Cabinets - 77 5/8" H.

Cabinet with 4 adjustable shelves.

Finished interior construction.

Lock & key included. Keyed-alike or NOKI lock available as an option.

Extra shelves and dividers available, [see p.69](#).

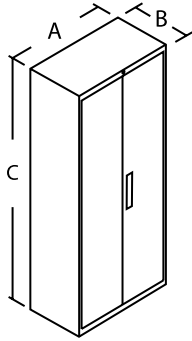
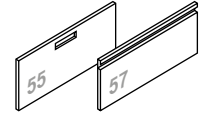

Dimensions			Code		Price		Spec.	
A	B	C	Series		Standard	Metallic	Cu.Ft	lb
WIDTH 30"								
30	18	77 5/8	55	55-68-030-YYYY	1632	1833	28.0	150
30	18	77 5/8	57	57-68-030-YYYY	1662	1863	28.0	150
WIDTH 36"								
36	18	77 5/8	55	55-68-036-YYYY	1667	1868	33.0	170
36	18	77 5/8	57	57-68-036-YYYY	1688	1889	33.0	170
WIDTH 42"								
42	18	77 5/8	55	55-68-042-YYYY	1777	1978	38.0	190
42	18	77 5/8	57	57-68-042-YYYY	1793	1994	38.0	190

S SPECIFY

O OPTION

Code Color Lock

- -

S Code: Consult the product code above.

Color: Specify the enamel finish, refer to the current Artopex enamel sample color cards. For metallic colors, refer to the "Metallic" column for pricing.

- O Lock:** • Keyed-alike option, with no charge: Specify **K01** to the components of the first group, **K02** to the components of the second group and so on, [see p.15](#).
- Noki electronic lock option (**LT1**) offered without upcharge, [see p.15](#).

Overfile cabinets - 24 1/4" H.

Cabinet with 1 adjustable shelf and sliding doors.

Extra shelves available, [see p.69](#).

The top of this overfile cabinet when placed on a unit of 53 3/8" H. will align with the top of a 77 5/8" H. unit.

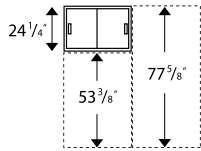
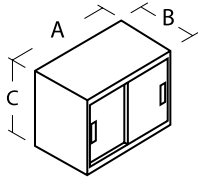
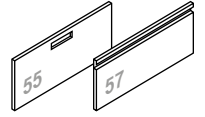

Dimensions			Code	Price		Spec.		
A	B	C	Series	Standard	Metallic	Cu.Ft	lb	
30	18	24 1/4	55	55-80-030-B	679	745	10.0	69
36	18	24 1/4	55	55-80-036-B	731	797	12.2	80
42	18	24 1/4	55	55-80-042-B	782	848	14.4	92

S SPECIFY

O OPTION

Code Color Lock

- -

S Code: Consult the product code above.

Color: Specify the enamel finish, refer to the current Artopex enamel sample color cards. For metallic colors, refer to the "Metallic" column for pricing.

- O Lock:**
 - Keyed-alike option, with no charge: Specify **K01** to the components of the first group, **K02** to the components of the second group and so on, [see p.15](#).
 - Noki electronic lock option (**LT1**) offered without upcharge, [see p.15](#).

Overfile cabinets - 25 7/16" H.

Cabinet with 1 adjustable shelf and sliding doors.

Extra shelves available, [see p.69](#).

The top of this overfile cabinet when placed on a 40 1/16" H. unit will align with the top of a 65 1/2" H. unit.

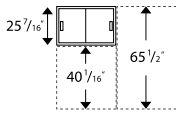
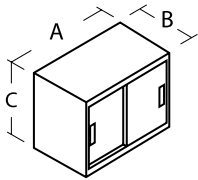
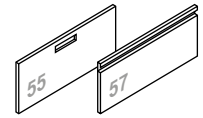

Dimensions			Code	Price		Spec.		
A	B	C	Series	Standard	Metallic	Cu.Ft	lb	
30	18	25 7/16	55	55-85-030-B	679	745	10.0	74
36	18	25 7/16	55	55-85-036-B	731	797	12.2	85
42	18	25 7/16	55	55-85-042-B	782	848	14.4	95

S SPECIFY

O OPTION

Code Color Lock

- -

S Code: Consult the product code above.

Color: Specify the enamel finish, refer to the current Artopex enamel sample color cards. For metallic colors, refer to the "Metallic" column for pricing.

- O Lock:**
- Keyed-alike option, with no charge: Specify **K01** to the components of the first group, **K02** to the components of the second group and so on, [see p.15](#).
 - Noki electronic lock option (**LT1**) offered without upcharge, [see p.15](#).

Bookcases



Bookcases - 27¹⁵/₁₆" H.

Bookcase with 1 adjustable shelf.

Finished interior construction.

Additional shelves and dividers available, [see p.69](#).

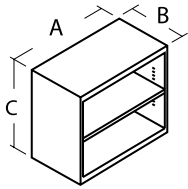

Dimensions				Code	Price		Spec.	
A	B	C	Series		Standard	Metallic	Cu.Ft	lb
DEPTH 30"								
30	18	27 ¹⁵ / ₁₆	70	70-20-030-Y	551	617	10.0	51
DEPTH 36"								
36	18	27 ¹⁵ / ₁₆	70	70-20-036-Y	596	662	12.2	56
DEPTH 42"								
42	18	27 ¹⁵ / ₁₆	70	70-20-042-Y	688	754	14.4	60

S SPECIFY

Code Color

-

S Code: Consult the product code above.

Color: Specify the enamel finish, refer to the current Artopex enamel sample color cards. For metallic colors, refer to the "Metallic" column for pricing.

Bookcases - 40¹/₁₆" H.

Bookcase with 2 adjustable shelves.
 Finished interior construction.
 Additional shelves and dividers available, [see p.69](#).

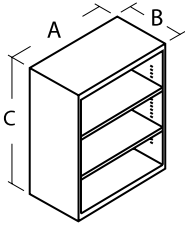

Dimensions			Code	Price		Spec.	
A	B	C	Series	Standard	Metallic	Cu.Ft	lb
DEPTH 30"							
30	18	40 1/16	70	70-30-030-YY	677	777	14.2 74
DEPTH 36"							
36	18	40 1/16	70	70-30-036-YY	732	832	17.3 80
DEPTH 42"							
42	18	40 1/16	70	70-30-042-YY	861	961	20.4 85

S SPECIFY

Code Color

-

S Code: Consult the product code above.
Color: Specify the enamel finish, refer to the current Artopex enamel sample color cards. For metallic colors, refer to the "Metallic" column for pricing.

Bookcases - 53 3/8" H.

Bookcase with 3 adjustable shelves.

Finished interior construction.

Additional shelves and dividers available, [see p.69](#).

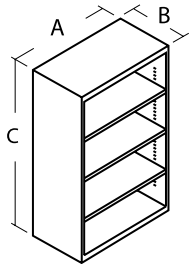

Dimensions				Code	Price		Spec.	
A	B	C	Series		Standard	Metallic	Cu.Ft	lb
DEPTH 30"								
30	18	53 3/8	70	70-40-030-YYY	847	980	18.9	97
DEPTH 36"								
36	18	53 3/8	70	70-40-036-YYY	908	1041	22.9	106
DEPTH 42"								
42	18	53 3/8	70	70-40-042-YYY	1022	1155	26.9	115

S SPECIFY

Code Color

-

S Code: Consult the product code above.

Color: Specify the enamel finish, refer to the current Artopex enamel sample color cards. For metallic colors, refer to the "Metallic" column for pricing.

Bookcases - 65 1/2" H.

Bookcase with 3 adjustable shelves.
 Finished interior construction.
 Additional shelves and dividers available, [see p.69](#).

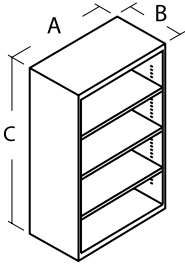

Dimensions			Code	Price		Spec.	
A	B	C	Series	Standard	Metallic	Cu.Ft	lb
DEPTH 30"							
30	18	65 1/2	70	70-50-030-YYY	952	1119	22.8 110
DEPTH 36"							
36	18	65 1/2	70	70-50-036-YYY	1044	1211	27.9 120
DEPTH 42"							
42	18	65 1/2	70	70-50-042-YYY	1345	1512	33.0 137

S SPECIFY

Code Color

-

S Code: Consult the product code above.
Color: Specify the enamel finish, refer to the current Artopex enamel sample color cards. For metallic colors, refer to the "Metallic" column for pricing.

Bookcases - 77 5/8" H.

Bookcase with 4 adjustable shelves.

Finished interior construction.

Additional shelves and dividers available, [see p.69](#).

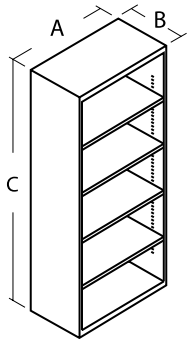

Dimensions			Code	Price		Spec.	
A	B	C	Series	Standard	Metallic	Cu.Ft	lb
DEPTH 36"							
36	18	77 5/8	70	70-60-036-YYYY	1332	1533	33.0 132

S SPECIFY

Code Color

-

S Code: Consult the product code above.

Color: Specify the enamel finish, refer to the current Artopex enamel sample color cards. For metallic colors, refer to the "Metallic" column for pricing.

Complements



Lateral file drawer compressor

Compressor with track for 12" drawer. Black finish.
For drawers with receding door only.

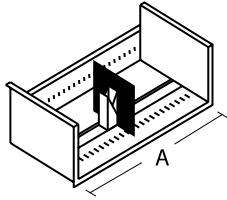

Dimension	Code	Price	Spec.	
			Cu.Ft.	lb
A				
30	AC-04-030	104	0.1	3
36	AC-04-036	104	0.1	3
42	AC-04-042	104	0.1	3

Dividers - sold by the unit

Divider, sold by the unit. Black finish.

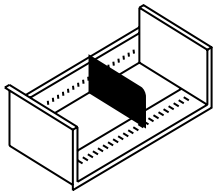

	Code	Price	Spec.	
			Cu.Ft.	lb
For 3" drawers	AC-04-281	9	0.1	1
For 6" and 9" drawers	AC-04-282	9	0.1	1
For 12" and 15" drawers	AC-04-283	9	0.1	1

Card tray - sold by the unit

Card tray, sold by the unit. Black finish.

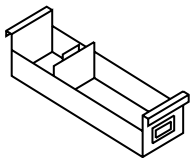

	Code	Price	Spec.	
			Cu.Ft.	lb
For 3"x 5" cards	AC-04-451	116	0.3	4
For 4"x 6" cards	AC-04-452	122	0.4	5
For 3"x 8" & 5"x 8" cards	AC-04-453	139	0.5	5

Lateral file counterweight

Counterweight for lateral files, sold separately.
Artopex recommends: • 2 counterweights for 2-drawer file cabinets.
• 1 counterweight for 3-drawer file cabinets.

For information on BIFMA requirements, contact Customer Service.

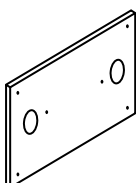

Dimension		Code	Price	Spec.	
A	C			Cu.Ft.	lb
24 1/2	6	AC-04-828	0.2	21	

Side-to-side hanging bar - sold by the unit

Hanging bar for lateral files, sold by the unit. Black finish.
Order 2 per drawer.

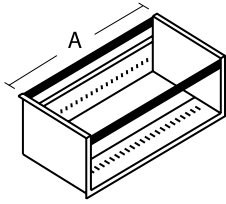

Dimension		Code	Price	Spec.	
A				Cu.Ft.	lb
30		AC-04-830	11	0.1	1
36		AC-04-836	11	0.1	1
42		AC-04-842	11	0.1	1

Front-to-back hanging bar - sold by the unit

Front-to-back hanging bar, sold by the unit, black finish
Order 4 per drawer for 30" or 36" wide drawers, 6 for 42" wide drawers.

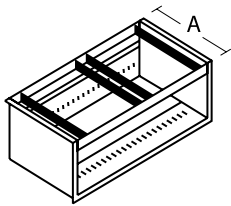

Dimension		Code	Price	Spec.	
A	C			Cu.Ft.	lb
18	6	AC-04-884	7	0.1	1

Pencil tray

Pencil tray for pedestal drawer. Black finish.

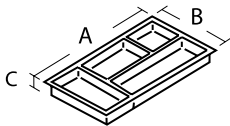

Dimension			Code	Price	Spec.	
A	B	C			Cu.Ft.	lb
12 3/4	5 1/2	1	AC-MP0814	22	0.1	1

Dividers for 6" drawer

Divider for 6" drawer (pedestal and combined lateral storage).
Black finish, set of 3.

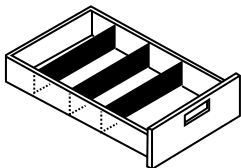

Dimension			Code	Price	Spec.	
A	B	C			Cu.Ft.	lb
12 3/4	5 1/2	1	AC-MPA0804	32	0.1	1

Compressor for 12" drawer

Compressor with rail for 12" drawer (pedestal). Black finish.

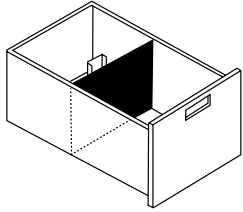

	Code	Price	Spec.	
			Cu.Ft.	lb
For 18" deep pedestal	AC-MP0818	92	0.1	5
For 22" deep pedestal	AC-MP0822	99	0.1	6
For 28" deep pedestal	AC-MP0828	104	0.1	7

Adjustable stopper

Should be installed under the work surface to prevent pedestal from tipping over.
Not required when pedestal is specified with casters.

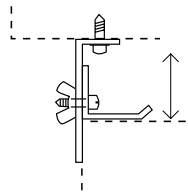

	Code	Prix	Spec.	
			Cu.Ft.	lb
	AC-MPS	33	0.1	4

Counterweight for pedestal

Counterweight for pedestal's stability.
Not required when pedestal is specified with casters.
Shipped separately from the pedestal.

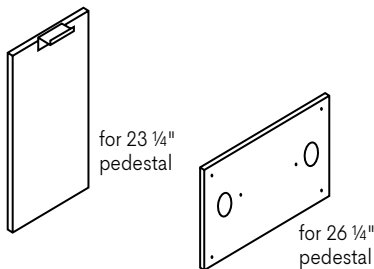

	Code	Prix	Spec.	
			Cu.Ft.	lb
For pedestals 23 1/4" high	AC-MPAC23	127	0.2	37
For pedestals 26 1/4" high	AC-MPAC26	172	0.2	37

Levellers

Replacement levellers, set of 4.
1/2" height adjustment.



Code	Price
AC-MP1	49

Casters

Casters for pedestal. Set of 5 (2 with a brake).
If levellers are replaced with casters, pedestal height will increase by 1 1/2".

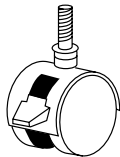

Code	Price
AC-MP2	89

Cushion

Cushion for pedestal.
Velcro® for installation included.

C.O.M. Fabric - CUS1518
0,75 v (0,70 m)

C.O.M. Fabric - CUS1522
0,80 v (0,75 m)

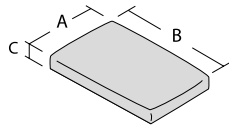

Dimensions			Code	Price					Spec.		
A	B	C		Gr.1	Gr.2/COM	Gr.3	Gr.4	Gr.5	Leather	Cu.Ft.	lb
15	18	1 1/2	AC-CUS1518	180	196	214	231	254	330	1.0	6
15	22	1 1/2	AC-CUS1522	191	208	226	243	272	347	1.0	6

S SPECIFY

Code

Fabric

-

S Code: Consult the product code above.

Tissu : Specify the fabric, refer to the current Artopex fabric sample card.

Additional shelves - regular (without perforations)

30", 36" or 42" wide shelves, without perforations.
Specify color.

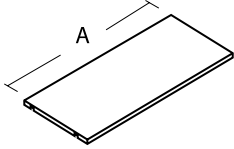

Dimension	Code	Price	Spec.	
A			Cu.Ft	lb
30	AC45-Y-030	75	0.6	7
36	AC45-Y-036	75	0.8	8
42	AC45-Y-042	75	0.9	9

S SPECIFY

Code Color

-

S Code: Consult the product code above.

Color: Specify the enamel finish, refer to the current Artopex enamel sample color cards. For metallic colors, refer to the "Metallic" column for pricing.

Additional shelves - perforated

30", 36" or 42" wide shelves, with perforations for dividers.
Specify color.

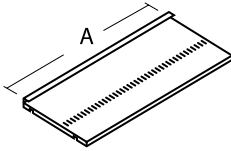

Dimension	Code	Price	Spec.	
A			Cu.Ft	lb
30	AC45-P-030	98	0.6	7
36	AC45-P-036	98	0.8	8
42	AC45-P-042	98	0.9	9

S SPECIFY

Code Color

-

S Code: Consult the product code above.

Color: Specify the enamel finish, refer to the current Artopex enamel sample color cards. For metallic colors, refer to the "Metallic" column for pricing.

Dividers

Dividers for metal shelves and panel-attached shelves for the Take Off System Furniture.
Set of 3, specify color.

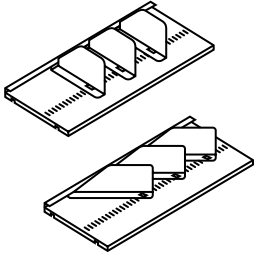

	Code	Prix	Spec.	
			pi ³	lb
Letter size	AC-04-KL06	32	0.2	4
Legal size	AC-04-KL45	56	0.4	6

S SPECIFY

Code Color

-

S **Code:** Consult the product code above.

Color: Specify the enamel finish, refer to the current Artopex enamel sample color cards. For metallic colors, refer to the "Metallic" column for pricing.

Shelves - for overfile cabinets

30", 36" or 42" wide shelves, without perforations.
Specify color.

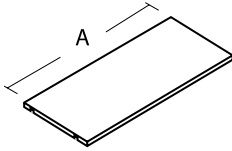

Dimension	Code	Price	Spec.	
A			Cu.Ft.	lb
30	AC45-B-030	74	0.6	7
36	AC45-B-036	74	0.8	8
42	AC45-B-042	74	0.9	9

S SPECIFY

Code Color

-

S Code: Consult the product code above.

Color: Specify the enamel finish, refer to the current Artopex enamel sample color cards. For metallic colors, refer to the "Metallic" column for pricing.

Summary of updates

Summary of updates

May 1st 2018

PAGES	SECTION	PRODUCT	MODIFICATION
p.15	Storage specifications	Storages.	New metal finish colors.
p.29	Lateral files	5-drawers lateral files - with fixed fronts.	Price correction: 57-51-030-1333.
p.44	Pedestals	Mobile pedestals.	Price correction: M45-18-3612CA.
p.55	Cabinets	Noki lock.	Lock only applicable for the cabinet 77 5/8 ".
p.66	Complements	Front-to-back hanging bar.	Dimension correction: 18" instead of 24".
p.66	Complements	Front-to-back hanging bar.	Title and description correction.

September 10th 2018

PAGES	SECTION	PRODUCT	MODIFICATION
		Conditions & Guarantees	Conditions & guarantees have been removed from the Metal price list. Please refer to the Artopex Warranty Guide in effect at artopex.com in the Member Zone / Documentation section.
p.15	General informations	Metal finish	New text.
p.60	Bookcase	Bookcase - 40 1/16" H.	Dimension correction.

March 15th 2019

PAGES	SECTION	PRODUCT	MODIFICATION
p.15	General information	Finish choice chart	The Ashen color is a metallic color.
p.46	Pedestals	Compact pedestals	New products.
p.59	Bookcase	Bookcase - 27 15/16" H.	Dimension correction.
p.66	Complements	Front-to-back hanging bar.	Corrections of the number of front-to-back hanging bar required.

June 17th 2019

PAGES	SECTION	PRODUCT	MODIFICATION
		Price list	General increase of 5% (QC-CAN-USA) exception of compact mobile pedestals.
p.47	Pedestals	Felt cushion for compact mobile pedestals	New products.
p.48	Pedestals	Fabric cushion for compact mobile pedestals	New products.

*Designing, manufacturing, advising,
planning and supporting: that's the art that
distinguishes our purpose at Artopex.*



ARTOPEX
Head Office
artopex.com

800 Vadnais Street
Granby, QC, Canada J2J 1A7
T 1 800 378 0189